



INSTRUCTION MANUAL

VHF MARINE TRANSCEIVER  
**IC-M87**

---

---

---

Icom Inc.



---

## IN CASE OF EMERGENCY

---

If your vessel requires assistance, contact other vessels and the Coast Guard by sending a distress call on Channel 16.

### ○ **USING CHANNEL 16**

#### **DISTRESS CALL PROCEDURE**

1. "MAYDAY MAYDAY MAYDAY."
2. "THIS IS ....." (name of vessel)
3. Your call sign or other indication of the vessel.
4. "LOCATED AT ....." (your position)
5. The nature of the distress and assistance required.
6. Any other information which might facilitate the rescue.

---

## RECOMMENDATION

---

**CLEAN THE TRANSCEIVER THOROUGHLY WITH FRESH WATER** after exposure to saltwater, and dry it before operation. Otherwise, the transceiver's keys, switches and controllers may become unusable due to salt crystallization.

**NOTE: DO NOT** wash the transceiver in water if there is any reason to suspect the waterproofing may not be effective. For example, in cases where the battery pack rubber seal is damaged, the transceiver/battery pack is cracked or broken, or has been dropped, or when the battery pack is detached from the transceiver.

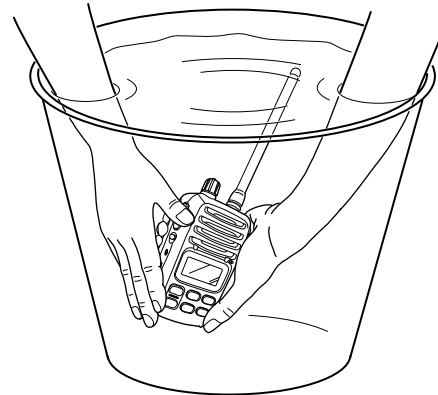

---

## FOREWORD

---

Thank you for purchasing this Icom product. The IC-M87 VHF MARINE TRANSCEIVER is designed and built with Icom's state of the art technology and craftsmanship. With proper care this product should provide you with years of trouble-free operation.

---

## IMPORTANT

---

**READ ALL INSTRUCTIONS** carefully and completely before using the transceiver.

**SAVE THIS INSTRUCTION MANUAL**—This instruction manual contains important operating instructions for the IC-M87.

---

## EXPLICIT DEFINITIONS

---

WORD	DEFINITION
<b>⚠ DANGER!</b>	Personal death, serious injury or an explosion may occur.
<b>⚠ WARNING!</b>	Personal injury, fire hazard or electric shock may occur.
<b>CAUTION</b>	Equipment damage may occur.
<b>NOTE</b>	If disregarded, inconvenience only. No risk of personal injury, fire or electric shock.

---

## FEATURES

---

### **22 free channels for PMR use**

The IC-M87 has 22 free channels reserved for PMR use (146–174MHz). Wide/narrow channel spacing is programmable for each channel, and CTCSS and DTCS signaling is included.

\*Appropriate license will be required.

### **Tough waterproof construction**

The IC-M87 is built tough to withstand hazardous and inhospitable environments at sea and on land. Even if the IC-M87 is dropped into water, its waterproofing\* will protect it from harm. The compact and durable body meets the military specifications (MIL-STD).

\* Equivalent to IPX7 of the corresponding International Standard IEC 529 (1989). (1m depth for 30 minutes)

### **Simple operation**

6 clearly labelled buttons on the front panel and the volume/power knob maximize simplicity of operation. Even when wearing gloves, the large buttons are easy to operate. A large, clear LCD with backlighting and backlit buttons make night time operation simple.

---

## PRECAUTIONS

---

**⚠ WARNING! NEVER** connect the transceiver to an AC outlet. This may pose a fire hazard or result in an electric shock.

**⚠ WARNING! NEVER** hold the transceiver so that the antenna is very close to, or touching exposed parts of the body, especially the face or eyes, while transmitting. The transceiver will perform best if the microphone is 5 to 10 cm away from the lips and the transceiver is vertical.

**CAUTION: NEVER** connect the transceiver to a power source other than the specified battery pack/case. Such a connection will ruin the transceiver.

**DO NOT** use or place the transceiver in direct sunlight or in areas with temperatures below  $-15^{\circ}\text{C}$  or above  $+55^{\circ}\text{C}$ : Marine, below  $-25^{\circ}\text{C}$  or above  $+55^{\circ}\text{C}$ : PMR.

**KEEP** the transceiver out of the reach of children.

**KEEP** the transceiver at least 0.9 meter away from your vessel's magnetic navigation compass.

**BE CAREFUL!** The transceiver meets IPX7\* requirements for waterproof protection. However, once the transceiver has been dropped, waterproof protection cannot be guaranteed because of possible damage to the transceiver's case or the waterproof seal.

\*Only when the battery pack, flexible antenna, [SP MIC] jack cover is attached.

**MAKE SURE** the flexible antenna and battery pack are securely attached to the transceiver, and that the antenna and battery pack are dry before attachment. Exposing the inside of the transceiver to water will result in serious damage to the transceiver.

After exposure to water, clean the battery contacts thoroughly with fresh water and dry them completely to remove any water or salt residue.

Icom, Icom Inc. and Icom logo are registered trademarks of Icom Incorporated (Japan) in Japan, the United States, United Kingdom, Germany, France, Spain, Russia and/or other countries.

---

# TABLE OF CONTENTS

---

IN CASE OF EMERGENCY .....	i	6 DUALWATCH/TRI-WATCH .....	15
RECOMMENDATION .....	i	■ Description .....	15
FOREWORD .....	ii	■ Operation .....	15
IMPORTANT .....	ii	7 LAND (PMR) CHANNEL OPERATION .....	16
EXPLICIT DEFINITIONS .....	ii	■ LAND (PMR) Channel Group .....	16
FEATURES .....	ii	■ Function display .....	16
PRECAUTIONS .....	iii	8 SET MODE .....	17-21
TABLE OF CONTENTS .....	iv	■ SET mode programming .....	17
1 OPERATING RULES .....	1	■ SET mode items .....	18
2 SUPPLIED ACCESSORIES AND ATTACHMENTS .....	2-3	9 BATTERY CHARGING .....	22-26
3 PANEL DESCRIPTION .....	4-7	■ Battery charging .....	22
■ Front, top and side panels .....	4	■ Cautions .....	22
■ Function display .....	6	■ Optional BP-226 battery case .....	24
4 BASIC OPERATION .....	8-12	■ AD-100 installation .....	25
■ Channel selection .....	8	■ Optional battery chargers .....	26
■ Receiving and transmitting .....	10	10 SPEAKER-MICROPHONE .....	27
■ Adjusting the squelch level .....	11	■ HM-138 Description .....	27
■ Automatic backlighting .....	11	■ Attachments .....	27
■ Lock function .....	11	11 TROUBLESHOOTING .....	28
■ Call channel programming .....	12	12 VHF MARINE CHANNEL LIST .....	29
5 SCAN OPERATION .....	13-14	13 SPECIFICATIONS .....	30
■ Scan types .....	13	14 OPTIONS .....	31
■ Setting tag channels .....	14	15 QUICK REFERENCE .....	32-33
■ Starting a scan .....	14	16 COUNTRY CODE LIST .....	34

## ◇ **Priorities**

- Read all rules and regulations pertaining to priorities and keep an up-to-date copy handy. Safety and distress calls take priority over all others.
- You must monitor Channel 16 when you are not operating on another channel.
- False or fraudulent distress calls are prohibited under law.

## ◇ **Privacy**

- Information overheard but not intended for you cannot lawfully be used in any way.
- Indecent or profane language is prohibited.

## ◇ **Radio licenses**

### **(1) SHIP STATION LICENSE**

When your craft is equipped with a VHF FM transceiver, you must have a current radio station license before using the transceiver. It is unlawful to operate a ship station which is not licensed.

Inquire through your dealer or the appropriate government agency for a Ship-Radiotelephone license. This license includes the call sign which is your craft's identification for radio purposes.

### **(2) OPERATOR'S LICENSE**

A restricted Radiotelephone Operator Permit is the license most often held by small vessel radio operators when a radio is not required for safety purposes.

The Restricted Radiotelephone Operator Permit must be posted near the transceiver or be kept with the operator. Only a licensed radio operator may operate a transceiver.

However, non-licensed individuals may talk over a transceiver if a licensed operator starts, supervises, ends the call and makes the necessary log entries.

A current copy of the applicable government rules and regulations is only required to be on hand for vessels in which a radio telephone is compulsory. However, even if you are not required to have these on hand it is your responsibility to be thoroughly acquainted with all pertinent rules and regulations.

# SUPPLIED ACCESSORIES AND ATTACHMENTS

## ◆ Supplied accessories

The following accessories are supplied:

	Qty.
• Swivel belt clip . . . . .	1
• Stopper for the swivel belt clip . . . . .	1
• Screws for the swivel belt clip . . . . .	2
• Flexible antenna . . . . .	1
• Handstrap . . . . .	1
• Battery pack . . . . .	1
• AC adapter . . . . .	1
• Battery charger . . . . .	1

## ◆ Swivel belt clip

To attach:

① Attach the stopper to the back of the transceiver.

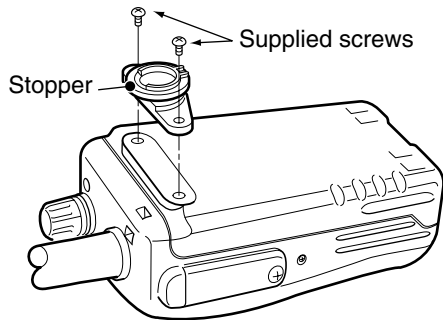

② Clip the belt clip to a part of your belt and insert the stopper to the belt clip.

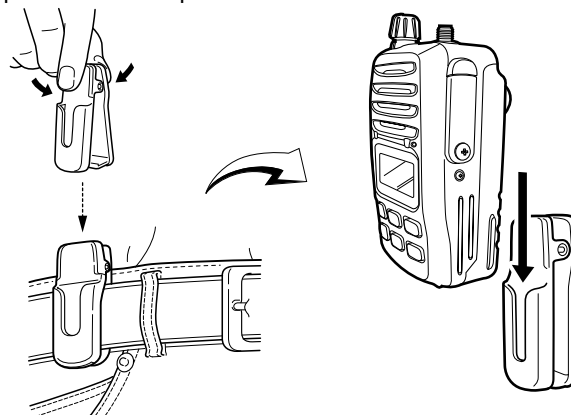

③ Once the transceiver is locked in place, it will swivel 360 degrees.

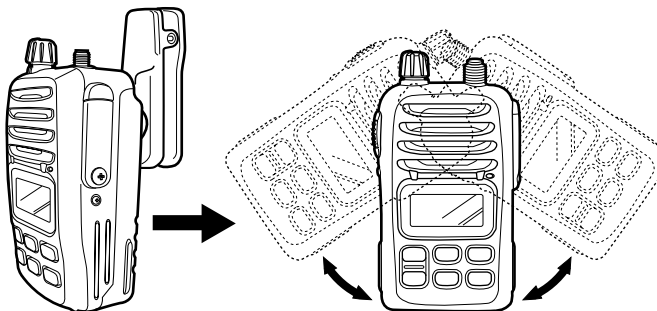

## 2 SUPPLIED ACCESSORIES AND ATTACHMENTS

*To remove:*

Turn the transceiver upside down, and then lift up to release the transceiver from the belt clip.

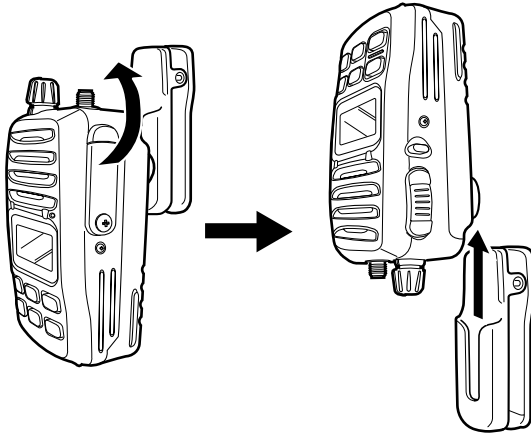

**CAUTION:**

**HOLD THE TRANSCEIVER TIGHTLY, WHEN ATTACHING OR REMOVING THE TRANSCEIVER FROM THE BELT CLIP.**

If the transceiver is accidentally dropped and the swivel belt clip's stopper is scratched or damaged, the swivel belt clip may not work properly.

◇ **Flexible antenna**

Connect the supplied flexible antenna to the antenna connector.

▨ **CAUTION:**

- Transmitting without an antenna may damage the transceiver.
- **NEVER** carry the transceiver by holding only the antenna.

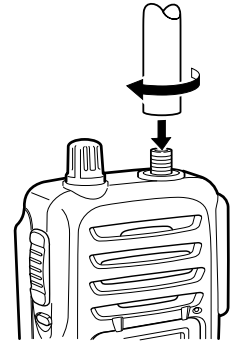

◇ **Handstrap**

Pass the handstrap through the loop on the back side of the transceiver as illustrated at right. This facilitates carrying.

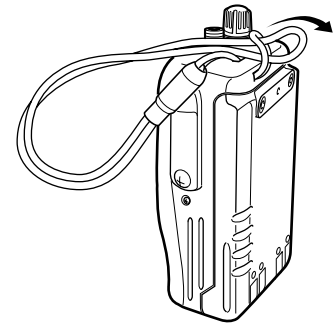



## ■ Front, top and side panels

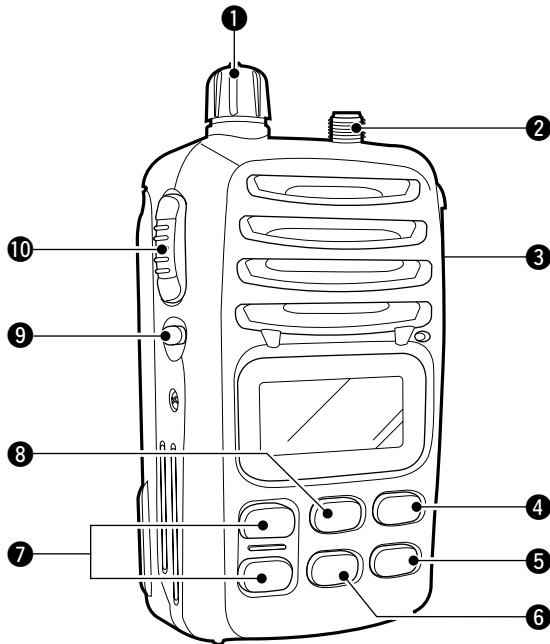

### 1 VOLUME CONTROL [VOL]

Turns power ON and adjusts the audio level.

### 2 ANTENNA CONNECTOR (p. 3)

Connects the supplied antenna.

### 3 SPEAKER-MICROPHONE CONNECTOR [SP MIC] (p. 27)

Connects the optional speaker-microphone.



[SP MIC] jack cover

**NOTE:** KEEP the [SP MIC] jack cover attached to the transceiver when the speaker-microphone is not in use.

### 4 SCAN [SCN•DUAL]

- Starts and stops normal or priority scan. (p. 14)
- Enters Watch mode when pushed for 1 sec. (p. 15)

### 5 TRANSMIT POWER/LOCK SWITCH [H/L•LOCK]

- Selects high, middle (except for the German version) or low power when pushed. (p. 10)
- Toggles the lock function ON/OFF when pushed for 1 sec. (p. 11)

### 6 CHANNEL 16 SWITCH [16•C]

- Selects Channel 16 when pushed. (p. 8)
- Selects the call channel when pushed for 1 sec. (p. 8)
- Enters call channel write mode when the call channel is selected and this switch is pushed for 3 sec. (p. 12)

### 3 PANEL DESCRIPTION

#### 7 CHANNEL UP/DOWN SWITCHES [▲]/[▼]

- Select an operating channel. (p. 9)
- Selects the SET mode condition of item. (p. 17)
- Checks tag channels or changes scanning direction during scan. (p. 14)
- Sets and clears the displayed channel as a tag (scanned) channel when pushed both switches for 1 sec.
- While turning power ON, clears all tag channels in the selected channel group when both switches are pushed.

#### 8 DIAL/CHANNEL GROUP SWITCH [DIAL]

- Selects one of 3 regular channels in sequence when pushed for 1 sec. (pp. 8, 9, 16)
  - International, USA (or ATIS\*) and LAND (PMR) channels are available. \*German version only
- Push to return to the condition before selecting the channel when the priority channel or the call channel is selected.

#### 9 SQUELCH SWITCH [SQL] (p. 11)

- Push this switch, then set the squelch level with [▲]/[▼].
- Manually opens the squelch for channel monitoring while pushed and held.
- While pushing this switch, turn the power ON to enter the set mode.

#### 10 PTT SWITCH [PTT]

Push and hold to transmit; release to receive.

#### ◇ BATTERY PACK RELEASE BUTTON

*To release the battery pack:*

Push the battery release button in the direction of the arrow (1) as shown below. The battery pack is then released.

*To attach the battery pack:*

Slide the battery pack on the back of the transceiver in the direction of the arrow (2), then lock it with the battery release button.

\*Slide the battery pack until the battery release button makes a 'click' sound.

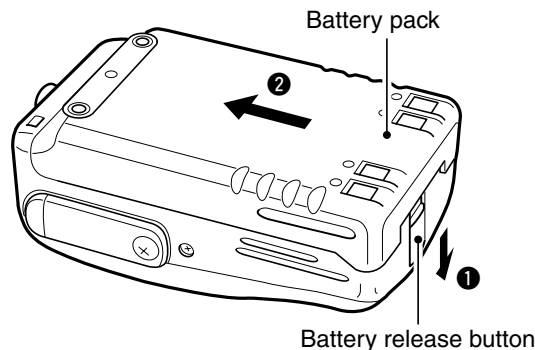

**CAUTION:** When pushing the battery release button, slide the battery pack slightly in the direction of the arrow (2) to ease release. This will prevent possible injuring to your fingers or nails

## ■ Function display

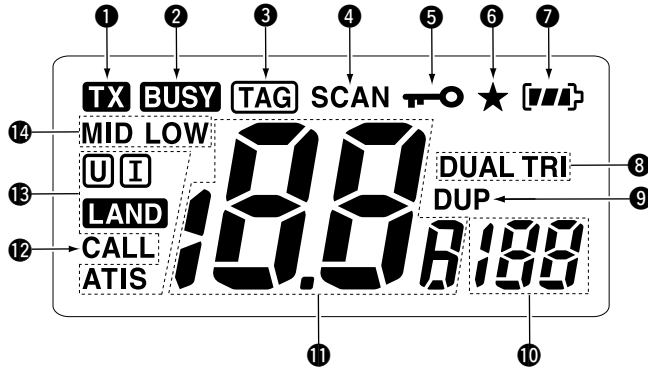

- 1 TRANSMIT INDICATOR** (p. 10)  
Appears while transmitting.
- 2 BUSY INDICATOR** (p. 10)
  - Appears when receiving a signal or when the squelch opens.
  - Blinks while monitoring.
- 3 TAG CHANNEL INDICATOR** (p. 14)  
Appears when a tag channel is selected.
- 4 SCAN INDICATOR** (p. 14)  
Blinks while scanning.
- 5 LOCK INDICATOR** (p. 11)  
Appears while the lock function is activated.
- 6 NARROW INDICATOR** (p. 16)  
Appears when narrow channel spacing is selected.  
\*LAND (PMR) channel group only.
- 7 BATTERY INDICATOR**  
Indicates remaining battery power.

Indication	[    ]	[   ]	[  ]	[ ]
Battery level	Full	Middle	Charging required	Discharged

[||||] blinks when the battery is over charged.

---

### 3 PANEL DESCRIPTION

#### 8 DUALWATCH/TRI-WATCH INDICATORS (p. 15)

“DUAL” appears during dualwatch; “TRI” appears during tri-watch.

#### 9 DUPLEX INDICATOR

Appears when a duplex channel is selected.

#### 10 SUB CHANNEL READOUT

- Indicates Channel 16 during priority scan, dualwatch or tri-watch. (p. 15)
- Indicates the SET mode item while in SET mode.

#### 11 CHANNEL NUMBER READOUT

- Indicates the selected operating channel number.
- In SET mode, indicates the selected condition.

#### 12 CALL CHANNEL INDICATOR (p. 8)

Appears when the call channel is selected.

#### 13 CHANNEL GROUP INDICATOR (pp. 9, 16)

“**I**” appears when International; “**U**” appears when U.S.A. (U.K. version only); “**LAND**” appears when LAND (PMR) channel group is selected. “ATIS” appears when the channel group in which ATIS function is activated. (German version only)

#### 14 TRANSMIT POWER INDICATOR (p. 10)

- “LOW” appears when low power is selected.
- “MID” appears when middle power is selected. (Except for the German version)
- No indication when high power is selected.

## ■ Channel selection

**IMPORTANT:** Prior to using the transceiver for the first time, the battery pack must be fully charged for optimum life and operation. To avoid damage to the transceiver, turn the power OFF while charging.

### ◇ Channel 16

Channel 16 (Distress channel) is used for establishing initial contact with another station and for emergency communications. Channel 16 is automatically monitored during both du-alwatch and tri-watch. While standing by, you must monitor Channel 16.

- ① Push [16•C] to select Channel 16.
- ② Push [DIAL] to return to the condition before selecting Channel 16, or push [▲]/[▼] to select the operating channel.

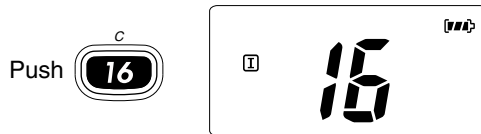

### ◇ Call channel

Each regular channel group has a separate call channel. In addition, each call channel is monitored during tri-watch. The call channels can be reprogrammed and are used to store your most often used channels in each channel group for quick recall.

- ① Push [16•C] for 1 sec. to select the call channel in the selected channel group.
  - “CALL” and the call channel number appear.
  - Each channel group may have its own call channel after programming a call channel. See the “Call channel programming” on page 12 for details.
- ② Push [DIAL] to return to the condition before selecting the call channel, or push [▲]/[▼] to select the operating channel.

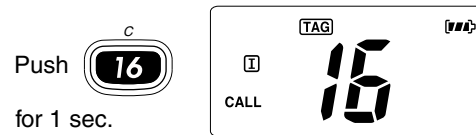

Channel 16 is the default setting.  
(depending on version)

## 4 BASIC OPERATION

### ◇ International, U.S.A and ATIS\* channels

There are 57 International, 58 U.S.A. and 57 ATIS\* channels. These channel groups may be specified for the operating area.

- ① Push [DIAL] to select a regular channel.
- ② Push [▲]/[▼] to select a channel.
  - “DUP” appears for duplex channels.
- ③ To change the channel group, push [DIAL] for 1 sec.
  - International, U.S.A. and ATIS\* channels can be selected in sequence. Depending on the setting, LAND (PMR) channel can be selected. See the “LAND (PMR) CHANNEL OPERATION” on page 16 for details.

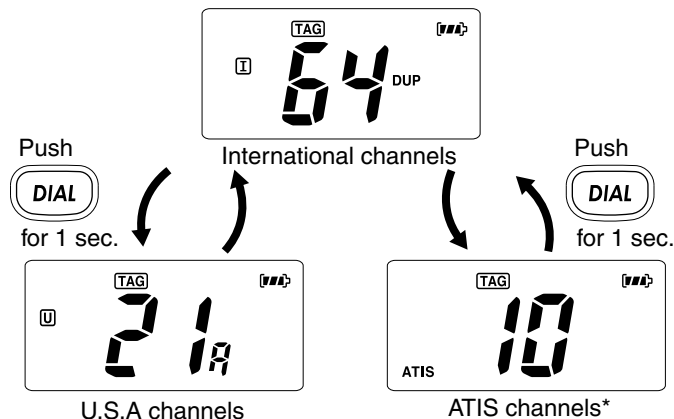

\* German version only

## ■ Receiving and transmitting

**CAUTION:** Transmitting without an antenna may damage the transceiver.

- ① Rotate [VOL] clockwise to turn power ON.
- ② Use the squelch function to mute any audio noise if necessary. After pushing the [SQL] for 1 sec., the squelch function is cut off until [SQL] is released. (default)
- ③ Push [SQL] for 1 sec. (see the SET mode on page 19), and rotate [VOL] to set the audio output level.
- ④ Push [▲]/[▼] to select the desired channel.
  - When receiving a signal, “**BUSY**” appears and audio is emitted from the speaker.
  - Further adjustment of [VOL] may be necessary at this point.
- ⑤ Push [H/L•LOCK] to select the output power if necessary.
  - “LOW” appears when low power is selected; “MID” appears when middle power is selected (except for the German version); no indication when high power is selected.
  - Choose low power to conserve battery power, choose high power for longer distance communications.
  - Some channels are for low power only.
- ⑥ Push and hold [PTT] to transmit, then speak into the microphone.
  - “TX” appears.
  - Channel 70 cannot be used for transmission (for GMDSS use).
- ⑦ Release [PTT] to receive.

**IMPORTANT:** To maximize the readability of your transmitted signal, pause a few sec. after pushing [PTT], hold the microphone 5 to 10 cm from your mouth and speak at a normal voice level.

**NOTE:** The transceiver has a power save function to conserve the battery power and it cannot be turned OFF. The power save function activates automatically when no signal is received for 5 sec.

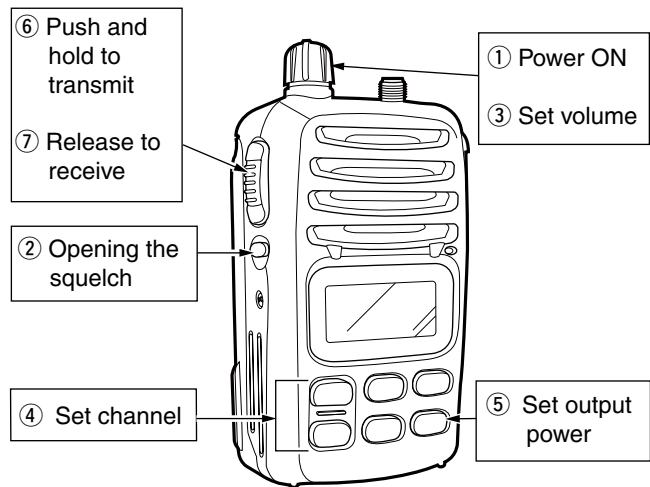

## 4 BASIC OPERATION

### ■ Adjusting the squelch level

The IC-M87 has a squelch even though there is no control knob for it. In order to receive signals properly, as well as for the scan to function effectively, the squelch must be adjusted to the proper level.

- ① Push [SQL], then adjust the squelch level with [▲]/[▼].
  - “SL” indicator appears.
  - There are 11 squelch levels to choose from: OP is completely open; 10 is the tight squelch level.
  - When no key is pushed for 5 sec., the transceiver returns to normal condition.
- ② Push [SQL] again to return to normal condition.



### ■ Lock function

This function electronically locks all keys (except for [PTT], [SQL] and [H/L•LOCK]) to prevent accidental channel changes and function access.

- ➔ Push [H/L•LOCK] for 1 sec. to turn the lock function ON and OFF.



Appears while the lock function is used.

### ■ Automatic backlighting

This function is convenient for nighttime operation. The automatic backlighting can be activated in SET mode. (p. 19)

- ➔ Push any key except for [PTT] to turn the backlighting ON.
- The backlighting is automatically turned OFF after 5 sec. of inactivity.



## ■ Call channel programming

The call channel key is used to select the default channel, however, you can program your most often-used channel in each channel group for quick recall.

- ① Push [DIAL] for 1 sec. several times to select the desired channel group (INT, USA) to be programmed.



- ② Push [16•C] for 1 sec. to select the call channel.
  - “CALL” and call channel number appear.



- ③ Push [16•C] again for 3 sec. (until a long beep changes to 2 short beeps) to enter call channel programming condition.
  - Call channel number to be programmed flashes.



- ④ Push [▲]/[▼] to select the desired channel.



- ⑤ Push [16•C] to program the displayed channel as the call channel.
  - The call channel number stop flashing.



## ■ Scan types

Scanning is an efficient way to locate signals quickly over a wide frequency range. The transceiver has priority scan and normal scan.

In addition, an auto scan function is available for standby convenience. (p. 18)

Set the tag channels (scanned channel) before scanning. Clear the tag channels which inconveniently stop scanning, such as digital communications.

⚡ Choose priority or normal scan in SET mode. (p. 18)

### PRIORITY SCAN

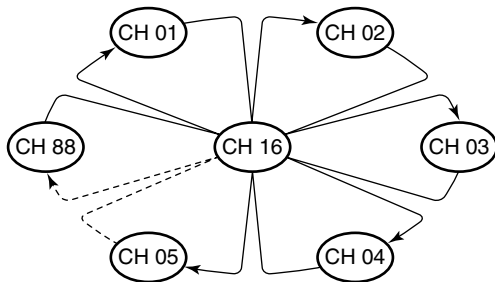

Priority scan searches through all tag channels in sequence while monitoring Channel 16. When a signal is detected on Channel 16, scan pauses until the signal disappears; when a signal is detected on a channel other than Channel 16, scan becomes dualwatch until the signal disappears.

### NORMAL SCAN

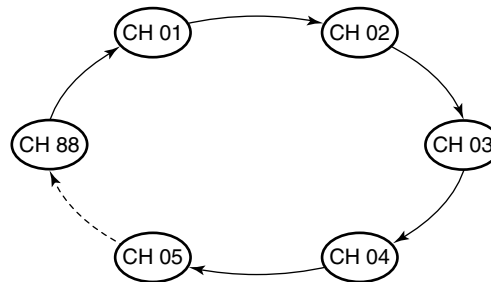

Normal scan, like priority scan, searches through all tag channels in sequence. However, unlike priority scan, Channel 16 is not checked unless Channel 16 is set as a tag channel.

## ■ Setting tag channels

For more efficient scanning, add desired channels as tag channels or clear tag channels for unwanted channels. Non-tag channels will be skipped during scanning. Tag channels can be assigned to each channel group (INT, USA) independently.

- ① Select the desired channel group (INT, USA) by pushing [DIAL] for 1 sec., if desired.
- ② Select the desired channel to set as a tag channel.
- ③ Push both [▲] and [▼] for 1 sec. to set the displayed channel as a tag channel.
  - “TAG” appears in the function display.
- ④ To cancel the tag channel setting, push both [▲] and [▼] for 1 sec.
  - “TAG” disappears.

### • Clearing all tag channels in the selected channel group

While pushing and holding both [▲] and [▼], turn power ON to clear all tag channels in the channel group.

## ■ Starting a scan

Set the priority scan function, scan resume timer and auto scan function in advance, using SET mode. (p. 18)

- ① Select the desired channel group (INT, USA) by pushing [DIAL] for 1 sec., if desired.
- ② Push [SCN•DUAL] to start priority or normal scan.
  - “SCAN” blinks in the function display.
  - “16” appears during priority scan.
  - When a signal is received, scan pauses until the signal disappears or resumes after pausing 5 sec. according to SET mode setting. (Channel 16 is still monitored during priority scan.)
  - Push [▲]/[▼] to check the scanning tag channels, to change the scanning direction or resume the scan manually.
- ③ To stop the scan, push [SCN•DUAL].
  - “SCAN” disappears.
  - Pushing [PTT], [16•C] or [DIAL] also stops the scan.

**[Example]:** Starting a normal scan.

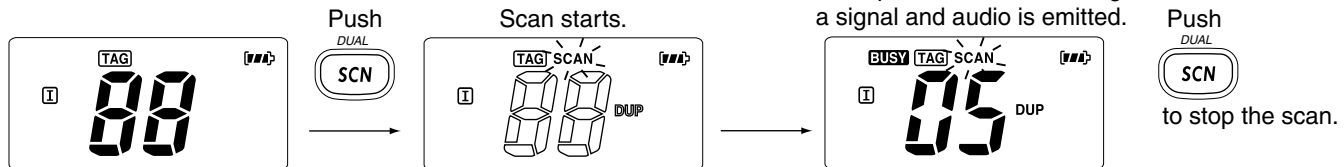

## ■ Description

Dualwatch monitors Channel 16 while you are receiving another channel; tri-watch monitors Channel 16 and the call channel while receiving another channel.

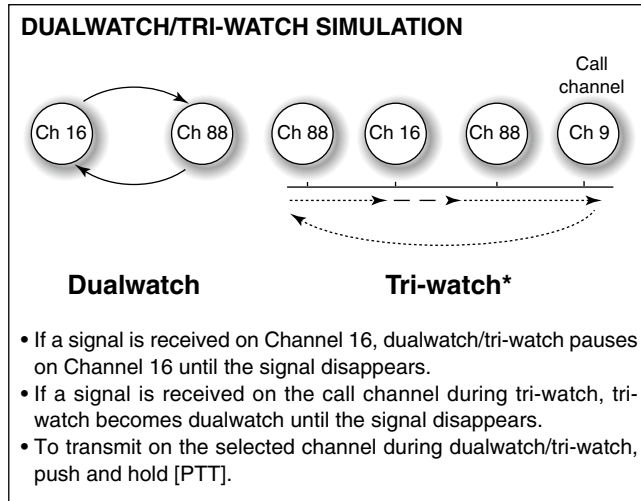

## ■ Operation

- ① Select the desired operating channel.
- ② Push [SCN•DUAL] to start dualwatch or tri-watch (depending on SET mode setting).
  - “DUAL” blinks during dualwatch; “TRI” blinks during tri-watch.
  - A beep tone sounds when a signal is received on Channel 16.
  - Tri-watch becomes dualwatch when receiving a signal on the call channel.
- ③ To cancel dualwatch/tri-watch, push [SCN•DUAL] again.

**[Example]:** Operating tri-watch on INT channel 07.

Push for 1 sec.



Tri-watch starts.



Signal is received on call channel.

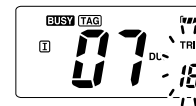

Signal received on Channel 16 takes priority.



Tri-watch resumes after the signal disappears.

## ■ LAND (PMR) Channel Group

A max. of 22 free LAND mobile channels (allocated 146.000 to 174.000 MHz) can be programmed into the LAND channel group for simple communication with PMR transceivers in the VHF band.

Moreover, any of the marine channels in the INT and USA channel groups can be programmed.

The default setting of the LAND channel group is the same as that of the INT channel group. Ask your local Icom dealer for the LAND channel group setting and PMR frequency programming details.

- ① Push [DIAL] to select a regular channel.
- ② To change the channel group, push [DIAL] for 1 sec. several times.
  - “LAND” appears when LAND (PMR) channel group is selected.
- ③ Push [▲]/[▼] to select a channel.
  - “DUP” appears for duplex channels.

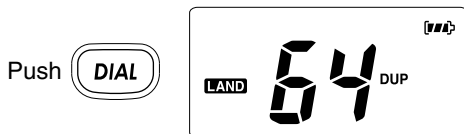

## ■ Function display

When Narrow, DTCS or CTCSS is set, the display shows the indications as below.

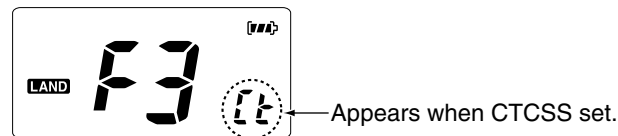
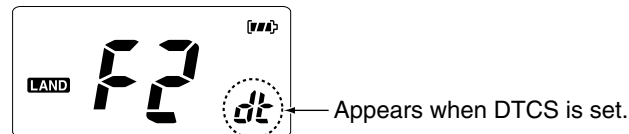
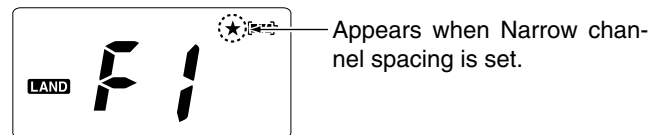

**NOTE:** The basic settings (e.g. call channel programming) are same as the International and U.S.A. channels. Refer to the appropriate pages for details.

## ■ SET mode programming

SET mode is used to change the condition of 11 transceiver functions: beep tone function, priority scan function, scan resume timer, auto scan function, dual/tri-watch function, monitor switch action, automatic backlighting, LCD contrast selection, auto power save function, self check function and battery voltage indicator.

### ◇ SET mode operation

- ① Turn power OFF.
- ② While pushing [SQL], turn power ON to enter SET mode.
  - “bp” appears.
- ③ Push [SQL] to select the desired item, if necessary.
- ④ Push [▲]/[▼] to select the desired condition of the item.
- ⑤ To exit SET mode, push [16•C].

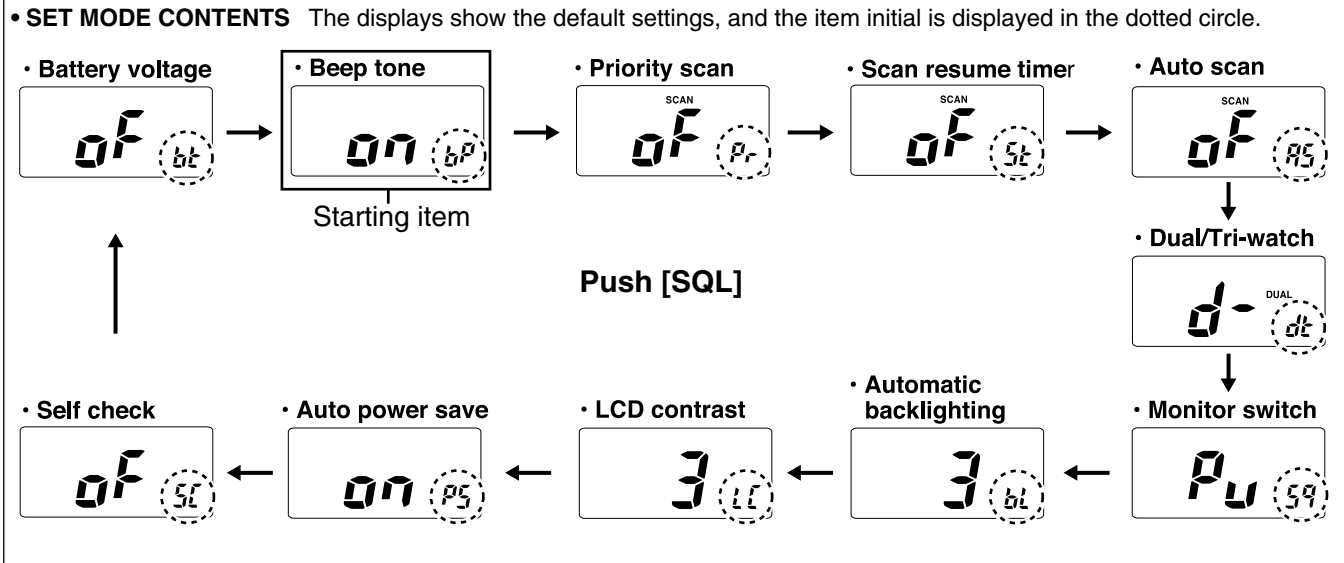

## ■ SET mode items

### ◇ Beep tone function “bP”

You can select silent operation by turning the beep tones OFF, or you can have 2 types of confirmation beeps sound at the push of a switch. When ON is selected, a fixed beep (Pi) sounds and when US is selected, the preset beeps (e.g. do, re, mi) sound.



Beep tone ON (default)



User Beep

### ◇ Priority scan function “Pr”

The transceiver has 2 scan types—normal and priority scans. Normal scan searches all tag channels in the selected channel group. Priority scan searches all tag channels in sequence while monitoring Channel 16.



Normal scan (default)



Priority scan

### ◇ Scan resume timer “St”

The scan resume timer can be set as a pause (OFF) or timer scan (ON). When OFF is selected, the scan pauses until a received signal disappears. When ON is selected, the scan pauses for 5 sec. after receiving a signal and then resumes even if the signal has been received.



Scan resume timer OFF (default)

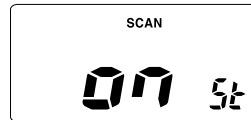

Scan resume timer ON

### ◇ Auto scan function “AS”

The Auto scan function starts the desired scan automatically when no signal is received, or no operation is performed for 30 sec.



Auto scan OFF (default)

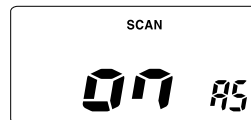

Auto scan ON

## 8 SET MODE

### ◇ Dual/Tri-watch function “dt”

This item selects dual or tri-watch as desired. See page 14 for details.

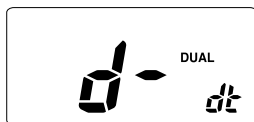

Dualwatch function  
(default)

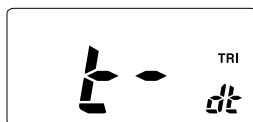

Tri-watch function

### ◇ Monitor switch action “Sq”

The monitor switch action cuts off the squelch function temporarily. This switch action contains PUSH (Pu) or HOLD (Ho) settings as shown below.

- Pu (PUSH): After pushing the [SQL] for 1 sec., the squelch opens and emits audio while pushing and holding [SQL]. (default)
- Ho (HOLD): After pushing the [SQL] for 1 sec., the squelch opens and emits audio even [SQL] is released. To close the squelch, push any key.



Monitor action PUSH  
(default)



Monitor action Hold

### ◇ Automatic backlighting “bl”

This function is convenient for nighttime operation. The automatic backlighting can be adjusted from OFF, 1 (dark)–3 (bright); 3 (default). Select 1–3 to turn this function ON.

- The automatic backlighting turns the backlighting ON when any key except for [PTT] is pushed.
- The backlighting is automatically turned OFF after 5 sec. of inactivity.

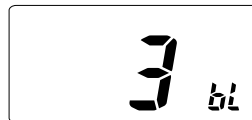

Automatic backlighting  
(default)



Automatic backlighting  
OFF

### ◇ LCD contrast selection “LC”

The contrast of the LCD can be adjusted from 4 levels.

- 1 (bright)–4 (dark); 3 (default)

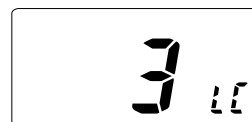

LCD contrast 3 (default)

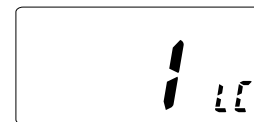

LCD contrast 1



◇ **Auto power save function “PS”**

The auto power save function reduces current drain by deactivating the receiver circuit for preset intervals.

- OFF : The power save function is turned OFF.
- ON : The power save function is turned ON. The power save function will be activated when no signal is received, and no operation is performed for 5 sec.



Auto power save ON  
(default)



Auto power save OFF

◇ **Self check function “SC”**

The self check function checks transceiver conditions by itself, and informs you in case a problem is found. The following items are checked after the power is turned ON, then it switches to operation mode.

- Temperature : Outside of  $-35^{\circ}\text{C}$  to  $+73^{\circ}\text{C}$  (approx.)
- Connected battery voltage
- Water intrusion



Self check OFF (default)



Self check ON

When error messages as shown below are displayed, see trouble shooting for advice (p. 28).

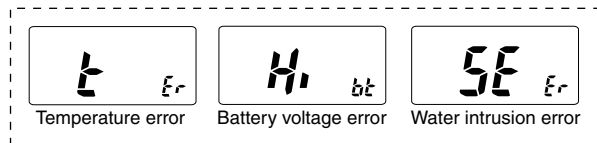

## 8 SET MODE

### ◇ Battery voltage indicator “bt”

This function contains display or non-display settings of the voltage of the connected battery pack when the power is ON.

- The voltage of the connected battery pack is displayed for 2 sec. after power is turned ON.



Battery voltage OFF  
(default)



Battery voltage ON

### SET MODE LIST

Function	Indication	Switch
Beep tone function	"bP"	OFF / ON* / US
Priority scan function	"Pr"	OFF* / ON
Scan resume timer	"St"	OFF* / ON
Auto scan function	"AS"	OFF* / ON
Dual/Tri-watch function	"dt"	Dual* / Tri
Monitor switch action	"Sq"	Push* / Hold
Automatic backlighting	"bL"	OFF / 1 / 2 / 3*
LCD contrast selection	"LC"	1 / 2 / 3* / 4
Auto power save function	"PS"	OFF / ON*
Self check function	"SC"	OFF* / ON
Battery voltage indicator	"bt"	OFF* / ON

\* default setting

## ■ Battery charging

Prior to using the transceiver for the first time, the battery pack must be fully charged for optimum life and operation.

**CAUTION:** To avoid damage to the transceiver, turn it OFF while charging.

- Recommended temperature range for charging:  
0°C to +40°C
  - The Li-ion battery is functioning within -10°C to +60°C
- Use the specified chargers (BC-119N, BC-121N and BC-152N). **NEVER** use another manufacturer's charger.
- Use the supplied AC adapter for BC-152N. **NEVER** use another manufacturer's AC adapter.

### **Recommendation:**

Charge the supplied battery pack for a maximum of up to 10 hours. Li-ion batteries are different from Ni-Cd batteries in that it is not necessary to completely charge and discharge them to prolong the battery life. Therefore, charging the battery in intervals, and not for extended periods is recommended.

## ■ Cautions

**NEVER** incinerate used battery packs. Internal battery gas may cause an explosion.

**NEVER** immerse the battery pack in water. If the battery pack becomes wet, be sure to wipe it dry immediately (particularly the battery terminals) BEFORE attaching it to the transceiver. Otherwise, the terminals will become corroded, or cause connection failure, etc.

**NEVER** short the terminals of the battery pack. Also, current may flow into nearby metal objects, such as a necklace, etc. Therefore, be careful when carrying with, or placing near metal objects, carrying in handbags, etc.

**AVOID** leaving the battery pack in a fully charged, or completely discharged condition for long time. It causes shorter battery life. In case of leaving the battery pack unused for a long time, it must be kept safely after discharge, or use the battery until the battery indicator shows the middle level, then remove it from the transceiver.

If your battery pack seems to have no capacity even after being charged, fully charge the battery pack again. If the battery pack still does not retain a charge (or very little), a new battery pack must be purchased.

## 9 BATTERY CHARGING

### ◇ Charging connections

- ① Attach the BC-152N to a flat surface, such as desk or cabin, if desired.
- ② Connect the AC adapter as shown below.
- ③ Insert the battery pack with/without the transceiver into the charger.
  - The charge indicator lights orange.
- ④ Charge the battery pack approximately 9–10 hours, depending on the remaining power condition.
  - The charge indicator lights green when charging is completed.

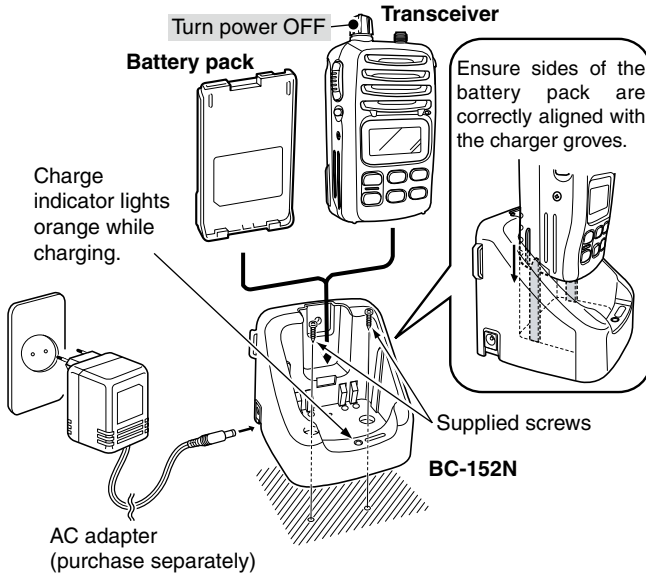

### ○ Charging indicator:

- Lights orange while charging.
- Lights green when charging is completed.
- Blinks orange or green, or does not light when a problem is detected.

### /// SOLUTIONS:

- Remove the battery pack, and reinsert it.
- Remove the battery pack, clean the battery terminals, then reinsert it.
- If the battery pack temperature is high, remove and let it cool down, then reinsert it.

If you are unable to solve the problem through the use of these solutions, the battery pack or the charger may be damaged, or the battery life may be over. In that case, contact your nearest Icom Dealer or Service Center.

/// **NOTE:** After charging is completed, the BC-152N will automatically recharge the battery pack when the battery voltage decreases. If the battery pack is often left in the charger for long periods, the battery life cycle will be shorter.

### ◇ For your convenience

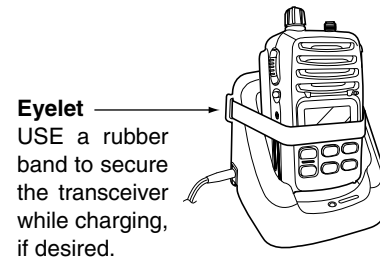

## ■ Optional BP-226 battery case

When using the optional battery case attached to the transceiver, install 5 × AA (LR6) size alkaline batteries as illustrated at right. The BP-226 is constructed to the IPX4 waterproof standard (IEC 60529, 2001).

- ① Hook your finger under the latch, and open the cover in the direction of the arrow (1). (Fig.1)
- ② Then, install 5 × AA (R6) size alkaline batteries. (Fig.2)
  - Install the alkaline batteries only.
  - Be sure to observe the correct polarity.
  - Be sure to pin the ribbon under the batteries. Leave enough of the ribbon ends extended, to pull when removing the batteries.
- ③ Close the cover with fitting in the direction of the arrow (2) first, then firm the latch in place (3). (Fig.1)
  - Be sure to the gasket and the ribbon are set correctly, and do not protrude out of the battery case. (Fig.3)

### CAUTION:

- When installing batteries, make sure they are all the same brand, type and capacity. Also, do not mix new and old batteries together.
- Keep battery contacts clean. It's a good idea to occasionally clean them.

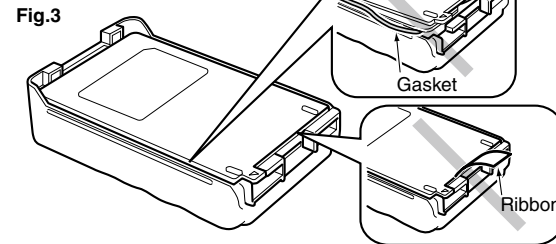
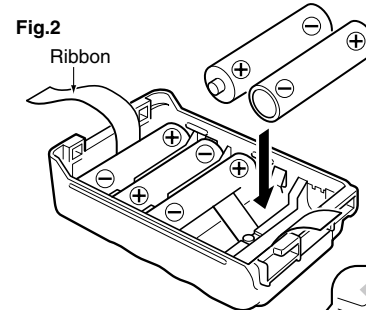
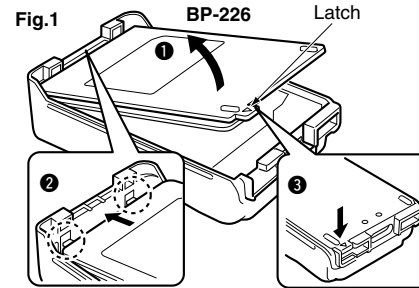

## 9 BATTERY CHARGING

### ■ AD-100 installation

The AD-100 CHARGER ADAPTER must be installed into the BC-119N or BC-121N before battery charging.

- ① Attach the plugs from the BC-119N/BC-121N to the AD-100 CHARGER ADAPTER.
- ② Secure the AD-100 into the holder space of the BC-119N/BC-121N with the supplied screws.

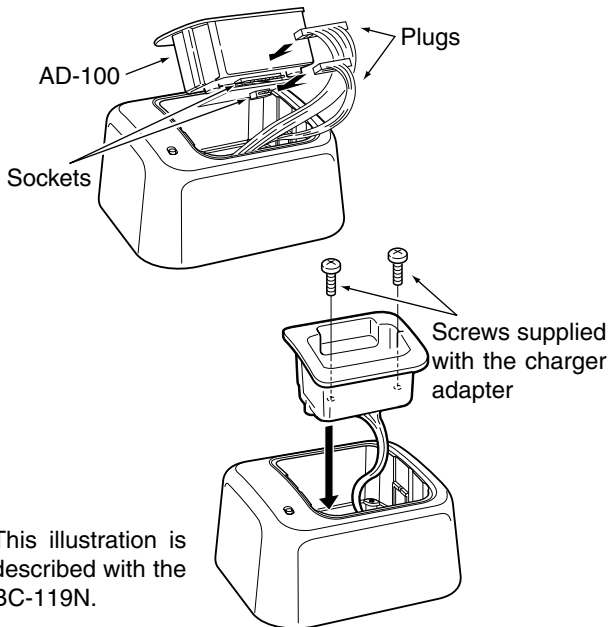

### ■ Optional battery chargers

#### ◇ Rapid charging with the BC-119N+AD-100

The optional BC-119N provides rapid charging of battery packs.

The following items are additionally required.

- AD-100 charger adapter
- An AC adapter (may be supplied with BC-119N depending on version) or the DC power cable (OPC-515L/CP-23L).

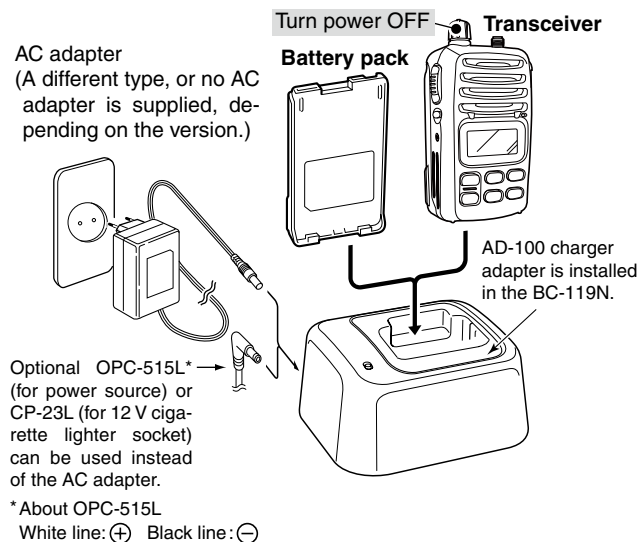

## ◇ Rapid charging with the BC-121N+AD-100

The optional BC-121N allows up to 6 battery packs to be charged simultaneously.

The following items are additionally required.

- Six AD-100 charger adapters
- An AC adapter (BC-157S) or the DC power cable OPC-656, supplied with the BC-121N.

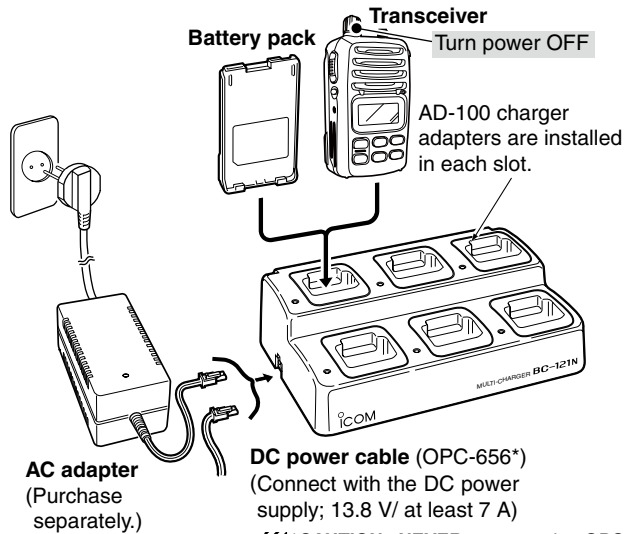

/// **\*CAUTION: NEVER** connect the OPC-656 to a power source using reverse polarity. This will ruin the battery charger.  
Red line: ⊕ Black line: ⊖

## /// **IMPORTANT: Battery charging caution**

/// Ensure the guide tabs on the battery pack are correctly aligned with the guide rails inside the charger adapter.  
/// (This illustration is described with the BC-119N.)

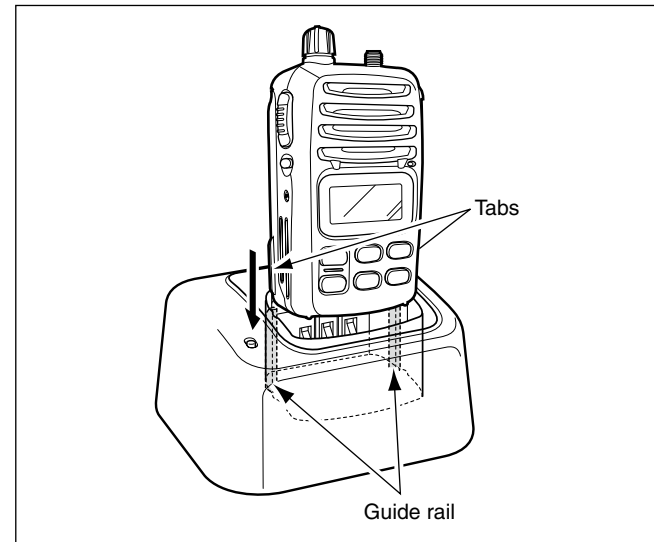

# 10 SPEAKER-MICROPHONE

## ■ HM-138 Description

### Alligator type clip

To attach the speaker-mic. to your shirt or collar, etc.

### PTT switch

Transmits during push  
Receives during release

### Microphone

### Speaker

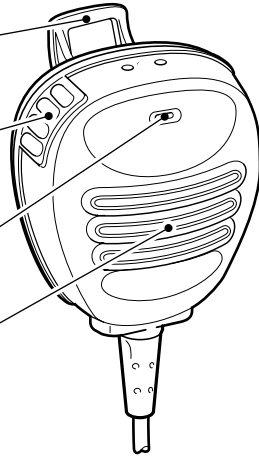

**NEVER** immerse the connector in water. If the connector becomes wet, be sure to dry it **BEFORE** attaching it to the transceiver.

**NOTE:** The microphone is located at the top of the speaker-microphone, as shown in the diagram above. To maximize the readability of your transmitted signal (voice), hold the microphone approx. 5 to 10 cm from your mouth, and speak in a normal voice level.

## ■ Attachments

Insert the connector of the speaker-microphone into the [SP MIC] connector on the transceiver and tighten the screw.

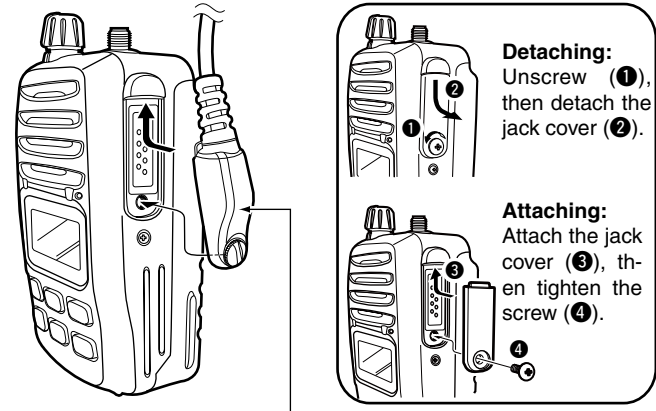

**Detaching:**  
Unscrew (1),  
then detach the  
jack cover (2).

**Attaching:**  
Attach the jack  
cover (3),  
then tighten the  
screw (4).

**CAUTION:** Attach the speaker-microphone's connector securely to prevent accidental dropping, or water intrusion in the connector.

**IMPORTANT: KEEP** the [SP MIC] jack cover attached (transceiver) when the speaker-microphone is not in use as illustrated above. Water will not get into the transceiver even if the cover is not attached, however, the terminals (pins) will become rusty, or the transceiver will function abnormally if the connector becomes wet.



# TROUBLESHOOTING 11

PROBLEM	POSSIBLE CAUSE	SOLUTION.	REF.
The transceiver does not turn ON.	<ul style="list-style-type: none"> <li>• The battery is exhausted.</li> <li>• Bad connection to the battery pack.</li> </ul>	<ul style="list-style-type: none"> <li>• Recharge the battery pack.</li> <li>• Check the connection to the transceiver.</li> </ul>	p. 22 p. 5
No sound from speaker.	<ul style="list-style-type: none"> <li>• Squelch level is too deep.</li> <li>• Volume level is too low.</li> <li>• Speaker has been exposed to water.</li> </ul>	<ul style="list-style-type: none"> <li>• Set squelch to the threshold point.</li> <li>• Set [VOL] to a suitable level.</li> <li>• Drain water from the speaker.</li> </ul>	p. 11 p. 10 —
Transmitting is impossible, or high power can not be selected.	<ul style="list-style-type: none"> <li>• Some channels are for low power or receive only.</li> <li>• The battery is exhausted.</li> <li>• The output power is set to low.</li> </ul>	<ul style="list-style-type: none"> <li>• Change channels.</li> <li>• Recharge the battery pack.</li> <li>• Push [H/L•LOCK] to select high power.</li> </ul>	pp. 8, 9, 29 p. 22 p. 10
The displayed channel cannot be changed.	<ul style="list-style-type: none"> <li>• Lock function is activated.</li> </ul>	<ul style="list-style-type: none"> <li>• Push [H/L•LOCK] for 1 sec. to cancel the function.</li> </ul>	p. 11
Scan does not start.	<ul style="list-style-type: none"> <li>• “TAG” channels are not programmed.</li> </ul>	<ul style="list-style-type: none"> <li>• Set the desired channels as “TAG” channels.</li> </ul>	p. 14
No beeps.	<ul style="list-style-type: none"> <li>• Beep tones are turned OFF.</li> </ul>	<ul style="list-style-type: none"> <li>• Set the beep tones to ON (Fix Beep/User Beep) in SET mode.</li> </ul>	p. 18
Self check error. (Temperature)	<ul style="list-style-type: none"> <li>• The temperature is outside of <math>-35^{\circ}\text{C}</math> to <math>+73^{\circ}\text{C}</math> (approx.)</li> </ul>	<ul style="list-style-type: none"> <li>• Leave the transceiver at room temperature for a while. Turn the power ON to check if the internal temperature has returned to normal.</li> </ul>	—
Self check error. (Battery voltage)	<ul style="list-style-type: none"> <li>• The connected battery pack’s voltage is more than 8.8 V.</li> </ul>	<ul style="list-style-type: none"> <li>• Verify the battery voltage is correct.</li> </ul>	—
Self check error. (Water intrusion)	<ul style="list-style-type: none"> <li>• Water has entered the transceiver.</li> </ul>	<ul style="list-style-type: none"> <li>• Have the transceiver checked at your local distributor or dealer to see whether the transceiver works properly or not.</li> </ul>	—

# 12 VHF MARINE CHANNEL LIST

## • International channels

CH	Frequency (MHz)		CH	Frequency (MHz)		CH	Frequency (MHz)		CH	Frequency (MHz)		CH	Frequency (MHz)		CH	Frequency (MHz)	
	Transmit	Receive		Transmit	Receive		Transmit	Receive		Transmit	Receive		Transmit	Receive		Transmit	Receive
01	156.050	160.650	11	156.550	156.550	21	157.050	161.650	62	156.125	160.725	72	156.625	156.625	82	157.125	161.725
02	156.100	160.700	12	156.600	156.600	22	157.100	161.700	63	156.175	160.775	73	156.675	156.675	83	157.175	161.775
03	156.150	160.750	13	156.650	156.650	23	157.150	161.750	64	156.225	160.825	74	156.725	156.725	84	157.225	161.825
04	156.200	160.800	14	156.700	156.700	24	157.200	161.800	65	156.275	160.875	75 <sup>†</sup>	156.775	156.775	85	157.275	161.875
05	156.250	160.850	15 <sup>†</sup>	156.750	156.750	25	157.250	161.850	66	156.325	160.925	76 <sup>†</sup>	156.825	156.825	86	157.325	161.925
06	156.300	156.300	16	156.800	156.800	26	157.300	161.900	67	156.375	156.375	77	156.875	156.875	87	157.375	157.375
07	156.350	160.950	17 <sup>†</sup>	156.850	156.850	27	157.350	161.950	68	156.425	156.425	78	156.925	161.525	88	157.425	157.425
08	156.400	156.400	18	156.900	161.500	28	157.400	162.000	69	156.475	156.475	79	156.975	161.575			
09	156.450	156.450	19	156.950	161.550	60	156.025	160.625	70	Rx only	156.525	80	157.025	161.625			
10	156.500	156.500	20	157.000	161.600	61	156.075	160.675	71	156.575	156.575	81	157.075	161.675			

## • USA channels (for U.K. version only)

CH	Frequency (MHz)		CH	Frequency (MHz)		CH	Frequency (MHz)		CH	Frequency (MHz)		CH	Frequency (MHz)		CH	Frequency (MHz)	
	Transmit	Receive		Transmit	Receive		Transmit	Receive		Transmit	Receive		Transmit	Receive		Transmit	Receive
01A	156.050	156.050	12	156.600	156.600	22A	157.100	157.100	64A	156.225	156.225	77 <sup>†</sup>	156.875	156.875	86	157.325	161.925
--	---	---	13 <sup>†</sup>	156.650	156.650	23A	157.150	157.150	65A	156.275	156.275	78A	156.925	156.925	86A	157.325	157.325
03A	156.150	156.150	14	156.700	156.700	24	157.200	161.800	66A	156.325	156.325	79A	156.975	156.975	87	157.375	161.975
--	---	---	15 <sup>†</sup>	156.750	156.750	25	157.250	161.850	67 <sup>†</sup>	156.375	156.375	80A	157.025	157.025	87A	157.375	157.375
05A	156.250	156.250	16	156.800	156.800	26	157.300	161.900	68	156.425	156.425	81A	157.075	157.075	88	157.425	162.025
06	156.300	156.300	17 <sup>†</sup>	156.850	156.850	27	157.350	161.950	69	156.475	156.475	82A	157.125	157.125	88A	157.425	157.425
07A	156.350	156.350	18A	156.900	156.900	28	157.400	162.000	70	Rx only	156.525	83A	157.175	157.175			
08	156.400	156.400	19A	156.950	156.950	37A	157.850	157.850	71	156.575	156.575	84	157.225	161.825			
09	156.450	156.450	20	157.000	161.600	61A	156.075	156.075	72	156.625	156.625	84A	157.225	157.225			
10	156.500	156.500	20A	157.000	157.000	--	---	---	73	156.675	156.675	85	157.275	161.875			
11	156.550	156.550	21A	157.050	157.050	63A	156.175	156.175	74	156.725	156.725	85A	157.275	157.275			

<sup>†</sup>Low power only.

# SPECIFICATIONS 13

## GENERAL

- Frequency coverage
  - Marine TX : 156.000–161.450 MHz
  - RX : 156.000–163.425 MHz
  - PMR TX/RX : 146.000–174.000 MHz
- Mode
  - Marine : 16K0G3E
  - PMR : 16K0F3E\* (Wide)/8K50F3E (Narrow)  
\*14K0F3E for German version
- Channel spacing
  - Marine : ±25 kHz
  - PMR : ±25 kHz (Wide)  
±20 kHz (Wide) <German ver.>  
±12.5 kHz (Narrow)
- Current drain (at 7.2 V DC) : TX at 5 W 1.6 A typical  
TX at 1 W 0.7 A typical  
Max. audio 200 mA typical  
Power save 20 mA typical
- Frequency stability : ±1.5 kHz (–25°C to +55°C)
- Usable temperature range
  - Marine : –15°C to +55°C
  - PMR : –25°C to +55°C
- Dimensions : 62 (W) × 97(H) × 37.8(D) mm\*
- Weight (approximately) : 274 g\*

\*When the BP-274 is attached.

## TRANSMITTER

- Output power (at 7.2 V DC) : 5/3/1 W  
1/0.5 W <German ver. Marine>
- Modulation system : Variable reactance frequency modulation
- Max. frequency deviation
  - Marine : ±5 kHz (Wide)
  - PMR : ±5 kHz (Wide)  
±4 kHz (Wide) <German ver.>  
±2.5 kHz (Narrow)
- Audio harmonics distortion : Less than 10% (at 60% mod.)
- Spurious emissions : 0.25 μW (below 2GHz)  
1 μW (above 2GHz)

## RECEIVER

- Receive system : Double-conversion superheterodyne
- Sensitivity (20 dB SINAD)
  - Marine : –2 dBμ EMF (typical)
  - PMR : –4 dBμ EMF (typical)
- Squelch sensitivity : 0 dBμ EMF (typical)
- Intermodulation rejection ratio
  - Marine : 68 dB
  - PMR : 65 dB
- Spurious response rejection ratio : 70 dB
- Adjacent channel selectivity : 70 dB (Wide)  
60 dB (Narrow; PMR only)
- Hum and noise ratio : 40 dB (Wide)  
34 dB (Narrow; PMR only)
- Audio output power
  - Marine : 0.2 W at 10% distortion with an 8 Ω load
  - PMR : 0.35 W typical at 10% distortion with an 8 Ω load

All stated specifications are subject to change without notice or obligation.

# 14 OPTIONS

## ◇ BATTERY PACKS/CASE

- **BP-226** BATTERY CASE  
Battery case for 5 × AA (R6) alkaline cells.
- **BP-227/BP-274** Li-ion BATTERY PACKS  
Voltage : 7.4 V  
Capacity: BP-227; 1850 mAh (minimum)/1950 mAh (typical)  
BP-274; 1800 mAh (minimum)/1900 mAh (typical)  
BP-227/BP-274 must be charged with the supplied BC-152N or the optional BC-119N/121N.

## ◇ CHARGER

- **BC-119N** DESKTOP CHARGER + **AD-100** CHARGER ADAPTER + **BC-145S** AC ADAPTER  
For rapid charging of battery packs. An AC adapter is supplied with the charger.  
Charging time: Approximately 2 to 2.5 hours
- **BC-121N** MULTI-CHARGER + **AD-100** CHARGER ADAPTER (6 pcs.) + **BC-157S** AC ADAPTER  
For rapid charging of up to 6 battery packs (six AD-100's are required) simultaneously. An AC adapter may be supplied depending on version.  
Charging time: Approximately 2 to 2.5 hours.
- **BC-152N** DESKTOP CHARGER + **BC-147S** AC ADAPTER  
Used for regular charging of battery pack. The same as supplied with the transceiver.  
Charging time: Approximately 10 hours

## ◇ OTHER OPTIONS

- **MB-79** BELT CLIP  
Exclusive alligator-type belt clip.
- **MB-86** SWIVEL BELT CLIP  
Swivel type belt clip. The same as supplied with the transceiver.
- **HM-138** SPEAKER-MICROPHONE  
Full-sized waterproof (IPX7 waterproof protection) speaker-microphones including alligator type clip to attach to your shirt or collar, etc.

Icom optional equipment is designed for optimal performance when used with this transceiver. We are not responsible for the transceiver being damaged or any accident caused when using non-Icom optional equipment.

Available or applicable options may differ according to countries. Ask your authorized dealer for details.

# QUICK REFERENCE 15

Important operating instructions are summed up in this and the following page for your simple reference.  
By cutting along the line and folding on the dotted line, it will become a card sized operating guide which can easily be carried in a card case or wallet, etc.

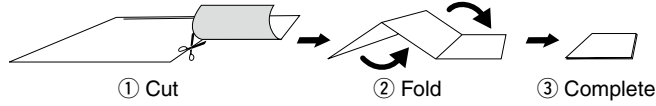

<CUT HERE>

## ICOM OPERATION GUIDE IC-M87

### ■ IN CASE OF EMERGENCY

#### ○ USING CHANNEL 16

- #### DISTRESS CALL PROCEDURE
1. MAYDAY MAYDAY MAYDAY.
  2. THIS IS (name of vessel)
  3. Your call sign or other indication of the vessel.
  4. LOCATED AT (your position)
  5. The nature of the distress and assistance required.
  6. Any other information which might facilitate the rescue.

### •CHANNEL SELECTION (pp. 8, 9, 16)



•Call channel  
Push [16] for 1 sec.



#### •International/USA/ATIS\* and LAND channels

\*German version only

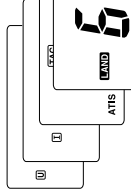
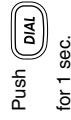

#### •Call channel programming (p. 12)

- ① Push [DIAL] for 1 sec. once or several times, to select the desired channel group.
- ② Push [16•C] for 1 sec. to select the call channel.
- ③ Push [16•C] for 3 sec. (until long beep changes to 2 short beeps)
- ④ Push [▲/▼] to select the desired channel.
- ⑤ Push [16•C] to program the displayed channel as the call channel.



■ **SET MODE** (pp. 17–21)

- ① While pushing [SQL], turn power ON.
- ② Push [SQL] again to select an item.  
  
Refer to pages 17–21 for set mode item.
- ③ Push [▲]/[▼] to select the desired condition.
- ④ Push [16+C] to return to regular operating mode.

■ **DUAL/TRI-WATCH** (p. 15)

- ① Push [▲]/[▼] to select the desired channel.
- ② Push [SCN+DUAL] for 1 sec. to start dualwatch or tri-watch depending on SET mode setting (p. 19).

■ **LOCK FUNCTION** (p. 11)

- Push  for 1 sec. to turn the lock function ON and OFF.
- 

■ **TAG CHANNELS** (p. 14)

- ① Push [▲]/[▼] to select the desired channel.
- ② Push both [▲] and [▼] for 1 sec. to set the displayed channel as a tag channel.

■ **SCAN** (p. 14)

- Push [SCN+DUAL] to start/stop scanning.

# COUNTRY CODE LIST 16

## • ISO 3166-1

	Country	Codes		Country	Codes
1	Austria	AT	18	Liechtenstein	LI
2	Belgium	BE	19	Lithuania	LT
3	Bulgaria	BG	20	Luxembourg	LU
4	Croatia	HR	21	Malta	MT
5	Czech Republic	CZ	22	Netherlands	NL
6	Cyprus	CY	23	Norway	NO
7	Denmark	DK	24	Poland	PL
8	Estonia	EE	25	Portugal	PT
9	Finland	FI	26	Romania	RO
10	France	FR	27	Slovakia	SK
11	Germany	DE	28	Slovenia	SI
12	Greece	GR	29	Spain	ES
13	Hungary	HU	30	Sweden	SE
14	Iceland	IS	31	Switzerland	CH
15	Ireland	IE	32	Turkey	TR
16	Italy	IT	33	United Kingdom	GB
17	Latvia	LV			

**Count on us!**

**< Intended Country of Use >**

AT BE CY CZ DK EE  
FI FR DE GR HU IE  
IT LV LT LU MT NL  
PL PT SK SI ES SE  
GB IS LI NO CH BG  
RO TR HR

A-6215H-1EU-⑥

Printed in Japan

© 2002–2012 Icom Inc.

Printed on recycled paper with soy ink.

**Icom Inc.**

1-1-32 Kamiminami, Hirano-ku, Osaka 547-0003, Japan