



FURUNO

FA-30

AIS RECEIVER



The FA-30 delivers “Real-Time” AIS info providing critical collision avoidance i



FA-30
AIS RECEIVER

Acquisition and tracking of traffic around your vessel is absolutely necessary for safe and efficient navigation. FURUNO's FA-30 AIS Receiver provides navigational data about other AIS-equipped vessels, increasing your situational awareness and allowing you to navigate more safely.

The FA-30 incorporates real-time AIS information into your radar, chart plotter or a PC. AIS targets are displayed with SOG/COG vector, which aids you in recognizing possible collisions and grasp the navigational situation at a glance,

even in congested waterways. Closest Point of Approach (CPA) and Time to Closest Point of Approach (TCPA) can be computed and displayed on-screen.

The FA-30 outputs AIS data to NavNet 3D and NavNet vx2 series as well as to PC with AIS Viewer software via an Ethernet connection. The FA-30 can also be interfaced with a FURUNO radar or chart plotter via NMEA0183 format to supplement those systems.

mation to navigation systems formation in all weather conditions

What is AIS?

The Automatic Identification System (AIS) enhances safe navigation by exchanging critical navigational data with nearby AIS-enabled targets. The system utilizes VHF broadcasts to handle information about nearby vessel traffic as well as aids-to-navigation.

AIS data includes vessel's name, position and course/speed over ground, allowing you to predict the course changes of other vessels. And since AIS targets are constantly visible even when they are shrouded in fog, in darkness, behind capes, river bends and other obstructions, this system helps you to avoid dangerous collisions.

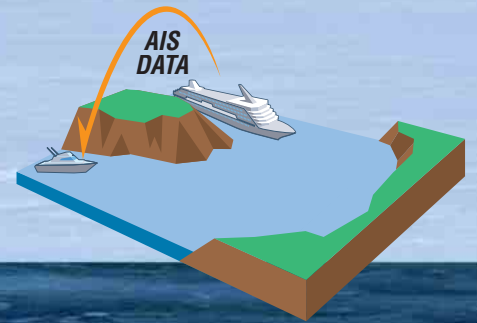

- ▶ Enhances safe navigation by receiving critical navigation information from local AIS-equipped vessels
- ▶ Vastly improves situational awareness in any weather conditions including dense fog, darkness, and congested waterways
- ▶ Dual parallel channel, "Full Duplex" receiver design receives AIS contact messages up to 100% more often than dual channel "Multiplexing" receivers
- ▶ High sensitivity, synthesized receiver automatically switches between international and local AIS channels
- ▶ Optional amplified VHF splitter allows the use of a single antenna for VHF radio and AIS Receiver
- ▶ Network output to NavNet 3D/vx2 and PCs for added redundancy and installation flexibility
- ▶ Serial Output for integration with various radar and chart plotter systems
- ▶ AIS Viewer Software included for on-board PC or land based installations
- ▶ Bulkhead mounting and low power, flexible DC input voltage design for simplified installations

Information to navigation systems in all weather conditions



FA-30
AIS RECEIVER

Information to be received

Dynamic Data

- Ship's position
- Coordinated universal time (UTC)
- Course over ground (COG)
- Speed over ground (SOG)
- Rate of turn (ROT)
- Heading
- Navigation status*

Static Data

- MMSI (Maritime Mobile Service Identity)
- IMO number*
- Ship's name
- Type of ship
- Call sign
- Length and beam
- Location of position-fixing antenna on the ship

Voyage Related Data

- Ship's draft*
- Hazardous cargo
- Destination and ETA*

Safety-related messages

* Class-A AIS only

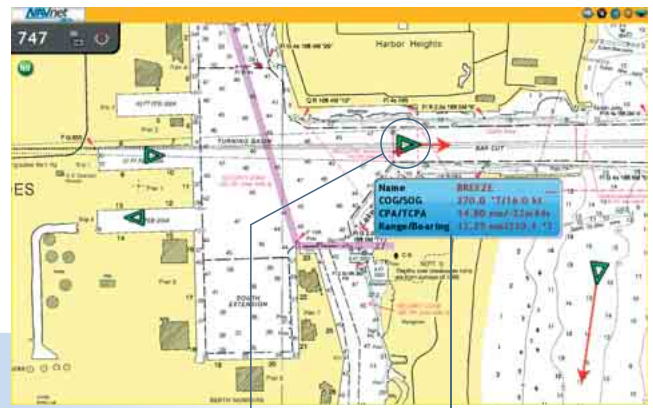

AIS target

AIS information

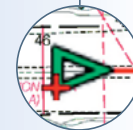

Name	BREEZE
COG/SOG	270.0 °T/16.0 kt
CPA/TCPA	14.80 nm/32m/44s
Range/Bearing	17.25 nm/210.1 °T



NavNet vx2 can also be interfaced to the FA-30



When placing a cursor onto the AIS target, an AIS data window will pop up to display the following data of the target: Ship's name, COG, SOG, CPA, TCPA, Range and Bearing.



AIS Viewer for PC (Standard supply)

The software can be upgraded to a full version of MaxSea Navigation Software or MaxSea-NavNet Software.

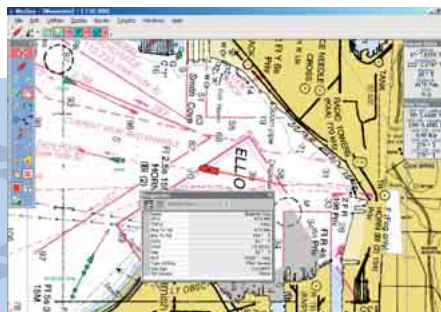

AIS info on NOAA chart

Rough raster chart is already installed. Also, additional charts can be installed into this viewer.

COG/SOG vector



Past track line

Display Options	
Brighter Day	
Name	Brighter Day
CPA	4.70 Nm
TCPA	+46°
Ring To Text	4.70 Nm
Brng To Text	264 ° T
COG	62 ° T
SOG	16.00 Kn
HDG	62 ° T
ROT	+0.00 ° /min
Type of Ship	Plot Vessel
Call Sign	1234567
Txt Danger	None

AIS target data for the selected vessel



Radar FR-8xx2 series

When interfacing with FR-8xx2 series, AIS interface IF-1500AIS is needed.



AIS target

AIS information

AIS target symbol

COG/SOG vector changes its length according to SOG.

ROT mark is viewable when the target vessel sends the information. Past track dots enables you to evaluate the target's action.

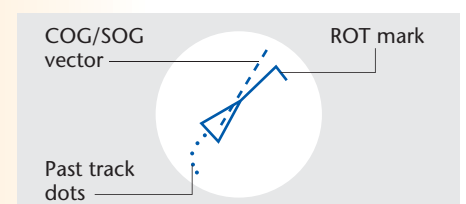

COG/SOG vector

ROT mark

Past track dots

SPECIFICATIONS OF FA-30

STANDARDS REFERRED

IMO Res. MSC.74 (69) Annex 3, ITU-R Rec. M.1371-2
IEC 61993-2 Ed.1 (Class-A AIS), IEC 62287-1 (Class-B CS-TDMA AIS),
IEC 60945 Ed.4, IMO Res. A.917 (22)

RECEIVING UNIT

RX Frequency 156.025 MHz to 162.025 MHz
Channel Spacing 25 kHz/12.5 kHz

INTERFACE

NMEA0183

Input: ACK, ACA, AIQ, DTM, GBS, GGA, GLL,
GNS, HDT, OSD, RMC, VBW, VTG, DSC,
DSE, ZDA, PFEC

Output (38.4kbps): VDM, VDO, ACA, ACS, ALR, TXT

Ethernet 10/100BASE-T

POWER SUPPLY 12-24 VDC, 1.2-0.6 A

ENVIRONMENT

Temperature (IEC 60945 Ed.4) -15 to +55 °C
Humidity (IEC 60945 Ed.4) +40 °C, 93%RH
Waterproofing (IEC 60529) IP20

EQUIPMENT LIST

Standard

1. AIS Receiver FA-30
with a Power/Serial combined cable 1 unit
2. AIS Viewer Software FAISPC-MX 1 set
3. Installation Materials and Spare Parts 1 set

Option

1. VHF Splitter Kit OP05-106
2. VHF Antenna 150M-W2VN
3. LAN Cable (2/10 m) for the connection with a PC
4. LAN Cable (1/5/10/20/30 m) for the connection with NavNet vx2

AIS RECEIVER

1.5 kg 3.3 lb

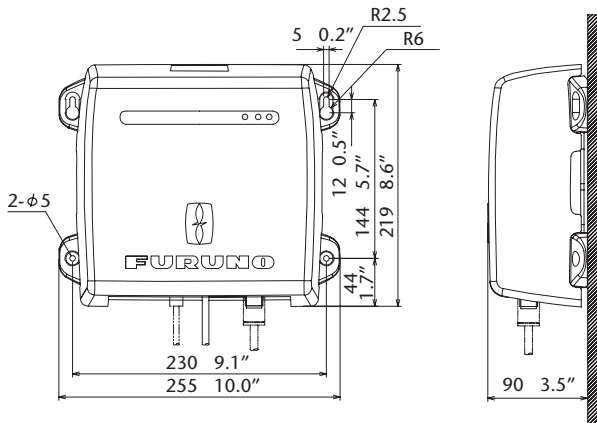

INTERCONNECTION DIAGRAM

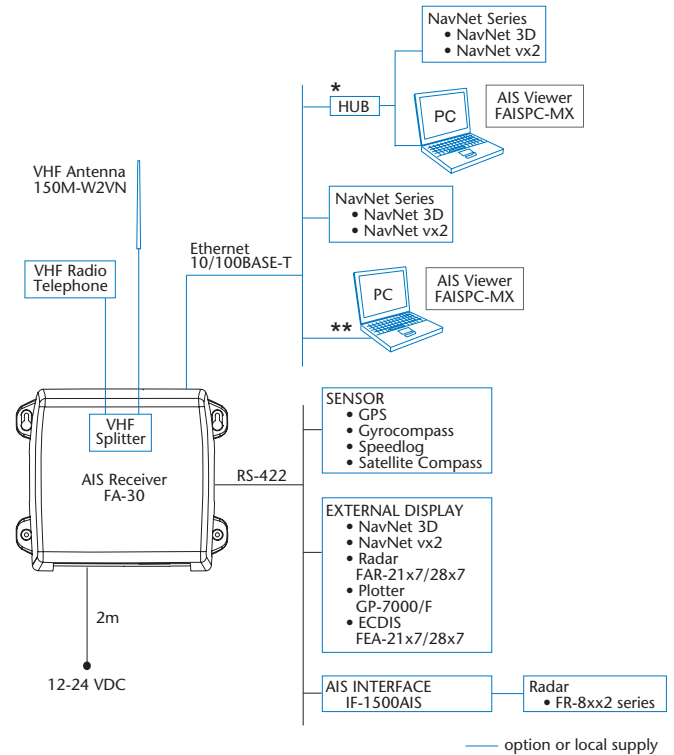

* When using a hub that is not compatible with AUTO MDI/MDI-X, a straight cable will be needed for connection. (Most hubs available are compatible with AUTO MDI/MDI-X).

** A crossing cable should be used.

TRADEMARK REGISTERED MARCA REGISTRADA
SPECIFICATIONS SUBJECT TO CHANGE WITHOUT NOTICE

FURUNO ELECTRIC CO., LTD.
Nishinomiya, Hyogo, Japan
Phone: +81 (0)798 65-2111
Fax: +81 (0)798 65-4200, 66-4622

FURUNO U.S.A., INC.
Camas, Washington, U.S.A.
Phone: +1 360-834-9300
Fax: +1 360-834-9400

FURUNO (UK) LIMITED
Havant, Hampshire, U.K.
Phone: +44 23 9244 1000
Fax: +44 23 9248 4316

FURUNO FRANCE S.A.
Bordeaux-Mérignac, France
Phone: +33 5 56 13 48 00
Fax: +33 5 56 13 48 01

FURUNO ESPAÑA S.A.
Madrid, Spain
Phone: +34 91-725-90-88
Fax: +34 91-725-98-97

FURUNO DANMARK AS
Hvidovre, Denmark
Phone: +45 36 77 45 00
Fax: +45 36 77 45 01

FURUNO NORGE A/S
Ålesund, Norway
Phone: +47 70 102950
Fax: +47 70 102951

FURUNO SVERIGE AB
Västra Frölunda, Sweden
Phone: +46 31-7098940
Fax: +46 31-497093

FURUNO FINLAND OY
Espoo, Finland
Phone: +358 9 4355 670
Fax: +358 9 4355 6710

FURUNO POLSKA Sp. z o.o.
Gdynia, Poland
Phone: +48 58 669 02 20
Fax: +48 58 669 02 21

FURUNO DEUTSCHLAND GmbH
Rellingen, Germany
Phone: +49 4101 838 0
Fax: +49 4101 838 111

LLC "FURUNO EURUS"
St. Petersburg, Russian Federation
Phone: +7 812 767 15 92
Fax: +7 812 766 55 52



80835U Printed in Japan
Catalogue No. N-867a

