

SIMRAD





RS12 VHF

User Guide

ENGLISH



IMPORTANT SAFETY INFORMATION
Please read carefully before installation and use.

	This is the safety alert symbol. It is used to alert you to potential personal injury hazards, Obey all safety messages that follow this symbol to avoid possible injury or death.
	WARNING indicates a potentially hazardous situation which, if not avoided, could result in death or serious injury
	CAUTION indicates a potentially hazardous situation which, if not avoided, could result in minor or moderate injury.
	CAUTION used without the safety alert symbol indicates a potentially hazardous situation which, if not avoided, may result in property damage.

DISCLAIMER: It is the owner's sole responsibility to install and use the instrument and transducers in a manner that will not cause accidents, personal injury or property damage. The user of this product is solely responsible for observing safe boating practices.

NAVICO HOLDING AS. AND ITS SUBSIDIARIES, BRANCHES AND AFFILIATES DISCLAIM ALL LIABILITY FOR ANY USE OF THIS PRODUCT IN A WAY THAT MAY CAUSE ACCIDENTS, DAMAGE OR THAT MAY VIOLATE THE LAW.

Governing Language: This statement, any instruction manuals, user guides and other information relating to the product

(Documentation) may be translated to, or has been translated from, another language (Translation). In the event of any conflict between any Translation of the Documentation, the English language version of the Documentation will be the official version of the Documentation.

This manual represents the RS12 as at the time of printing. Navico Holding AS. and its subsidiaries, branches and affiliates reserve the right to make changes to specifications without notice.

Copyright © 2012 Navico Holding AS. Simrad® is a registered trademark of Navico Holding AS.

FCC Statement

Note: This equipment has been tested and found to comply with the limits for a Class B digital device, pursuant to Part 15 of the FCC Rules. These limits are designed to provide reasonable protection against harmful interference in a normal installation. This equipment generates, uses and can radiate radio frequency energy and, if not installed and used in accordance with the instructions, may cause harmful interference to radio communications. However, there is no guarantee that interference will not occur in a particular installation. If this equipment does cause harmful interference to radio or television reception, which can be determined by turning the equipment off and on, the user is encouraged to try to correct the interference by one or more of the following measures:

- Reorient or relocate the receiving antenna.
- Increase the separation between the equipment and receiver.
- Connect the equipment into an output on a circuit different from that to which the receiver is connected.
- Consult the dealer or an experienced technician for help.
- A shielded cable must be used when connecting a peripheral to the serial ports.

RF Emissions Notice:

This equipment complies with FCC radiation exposure limits set forth for an uncontrolled environment. This device's antenna must be installed in accordance with provided instructions; and it must be operated with minimum 96 cm spacing between the antennas and all person's body (excluding extremities of hands, wrist and feet) during operation. Further, this transmitter must not be co-located or operated in conjunction with any other antenna or transmitter.

IMPORTANT:

1. DSC functions will not operate on the RS12 until your MMSI has been entered. Refer to section 4.2 for details.
2. The radio channels installed into this Simrad VHF radio may vary from country to country depending upon the model and government or national communications authority regulations.
3. Navico recommends that you check the radio operating licensing requirements of your country before using this Simrad VHF radio. The operator is solely responsible for observing proper radio installation and usage practices.
4. A DSC warning label is supplied with this Simrad VHF radio. To comply with FCC regulations, this label must be affixed in a location that is clearly visible from the operating controls of this radio. Make sure that the chosen location is clean and dry before applying this label.

MMSI and License Information:

You must obtain a user MMSI (Marine Mobile Service Identity) and enter it into your RS12 in order to use the DSC functions. Contact the appropriate authorities in your country. If you are unsure who to contact, consult your Simrad dealer.

The user MMSI is a unique nine digit number, similar to a personal telephone number. It is used on marine transceivers that are capable of using DSC (Digital Select Calling).

Depending upon your location, you may need a radio station license for the RS12. You may also need an individual operator's license.

Simrad recommends that you check the requirements of your national radio communications authorities before operating DSC functions.

Section 1 - General Information	7
1-1 Features	7
1-2 Customizing your Simrad VHF Radio	8
1-3 How to Display and Navigate Menus.....	8
1-4 How to Enter Alphanumeric Data	8
1-5 LCD Symbols and Meanings	8
1-6 Basic Operation and Key Functions.....	10
Section 2 - The Radio Menu (MENU)	14
2-1 Radio Menu Options (Menu)	14
2-2 Maintain Your Buddy List (BUDDY LIST).....	15
2-2-1 Add an Entry	15
2-2-2 Edit an Entry	15
2-2-3 Delete an Entry.....	16
2-3 Local or Distance Sensitivity (LOCAL/DIST).....	16
2-3-1 Set DISTANT Sensitivity.....	16
2-3-2 Set LOCAL Sensitivity.....	16
2-4 Backlighting (BACKLIGHT) and Contrast (CONTRAST).....	16
2-4-1 Set the Backlighting Level	17
2.4.2 Set the Contrast Level.....	17
2-5 GPS Data and Time (GPS/DATA)	17
2-5-1 Manually Enter Position and UTC Time (MANUAL)	17
2-5-2 Local Time (TIME OFFSET)	18
2-5-3 Time Format Options (TIME FORMAT)	18
2-5-4 Time Display Options (TIME DISPLAY)	19
2-5-5 Position Display Options (LL display).....	19
2-5-6 Course & Speed Display Options (COG/SOG).....	19
2-5-7 GPS Alert Options (ALERT)	20
2-6 GPS Simulator (SIMULATOR)	20
2-7 Reset to Factory Defaults (RESET)	20
Section 3 - Radio Setup Menu (RADIO SETUP)	21
3-1 Radio Setup Menu (RADIO SETUP)	21
3-2 Channel (UIC).....	21
3-3 Channel Names (CH NAME).....	22
3-4 RING & BEEP Volume (RING VOLUME) and (KEY BEEP).....	22
3-5 Internal Speaker Connections (INT SPEAKER).....	22
3-6 Set the Priority Channel (WATCH MODE)	23
3-7 Weather Alert (Wx ALERT)	23

3-8 NMEA protocol (COM PORT).....	23
3-9 Select the GPS Source (GPS SOURCE).....	24
Section 4 - DSC Setup Menu (DSC SETUP).....	25
4-1 DSC Setup - Menu Options.....	25
4-2 Enter or View Your USER MMSI (USER MMSI)	25
4-2-1 Enter your MMSI.....	25
4-2-2 View your MMSI	26
4-3 Maintain Your Groups (GROUP SETUP)	26
4-3-1 Create a Group (GROUP SETUP).....	26
4-3-2 Edit Group Name Details	27
4-3-3 Delete a Group	27
4-4 Response to Individual Calls (INDIV REPLY).....	27
4-5 ATIS MMSI & ATIS Functionality.....	28
4-5-1 Enter or Edit YOUR ATIS MMSI	28
4-5-2 View your ATIS MMSI.....	28
4-5-3 Enable ATIS Functionality (ATIS FUNC).....	29
4-6 DSC functionality options (DSC FUNC)	29
4-7 Response Type to LL Polling Calls (LL REPLY).....	29
4-8 Automatic Channel switching (AUTO SWITCH).....	30
4-9 DSC Test Reply (TEST REPLY).....	31
4-10 Set the inactivity timer (TIMEOUT)	31
Section 5 - Sending and Receiving DSC Calls	32
5-1 What is DSC?	32
5-2 Sending DSC calls	32
5-2-1 Make a Routine Call (INDIVIDUAL).....	33
5-2-2 Retrying a Routine Call	34
5-2-3 Acknowledgement of an Individual Incoming Call (INDIV)	34
5-2-4 Recall the Most Recent Incoming Call (LAST CALL)	34
5-2-5 Call a Group (GROUP).....	35
5-2-6 Call All Ships (ALL SHIPS).....	35
5-2-7 Call using the Call Log (CALL LOG).....	35
5-2-8 Call using the Distress Log (DISTR LOG).....	36
5-2-9 Call using the Sent Call Log (SENT CALL).....	37
5-2-10 Request the LL Position of a Buddy (LL REQUEST)	37
5-2-11 Make a DSC test call (DSC TEST)	38
5-3 Receiving DSC Calls.....	39
5-3-1 Receiving an All Ships Call (ALL SHIPS).....	40
5-3-2 Receiving an Individual Call (INDIV).....	40
5-3-3 Receiving a Group Call (GROUP).....	41

5-3-4 Receiving a Geographic Call (GEOGRAPH).....	42
5-3-5 Receiving a Polled Position Call (POSITION)	42
Section 6 - Distress Calls	43
6-1 Sending a Distress Call	43
6-2 Receiving a Distress Call (DISTRESS!)	45
6-3 Distress Acknowledgement (DISTRESS ACK)	45
6-4 Distress Relay Individual (INDIV DISTR RELAY)	46
Section 7 - Installation	47
Installation Options	47
Location Requirements	47
Checklist.....	48
Gimbal Installation.....	49
Change the Viewing Angle	49
Recessed Installation.....	49
Install the Microphone Bulkhead Mount.....	50
Fix the DSC label	51
Connect the Radio Cables	51
Set Up the Radio	53
The Completed Installation	54
Appendix A - Technical Specifications	55
Appendix B - Troubleshooting.....	57
Appendix C - US & ROW VHF Marine Channel Charts.....	58
C-1 International Channel Chart.....	58
Special Notes on International Channel Usage.....	59
C-2 USA Channel Chart.....	60
Special Notes on USA Channel Usage	61
C-3 CANADA Channel Chart.....	62
Special Notes on Canada Channel Usage.....	63
C-4 US & Canada WEATHER Channels	64
Appendix D - EU VHF Marine Channel Charts.....	65
D-1 EU International Channel Chart.....	65
Special Notes on EU International Channel Usage.....	66
D-2 Inland Waterways Country Specific table - ATIS ON	67
D-3 Special Channels ²	70

Section 1 - General Information

1-1 Features

Congratulations on your purchase of this Simrad RS12 marine band VHF radio. Your RS12 provides the following useful features:

- Prominent channel display
- Adjustable contrast settings for the LCD
- Adjustable keypad backlighting for easy night-time use
- Waterproof and submersible to comply with JIS-7
- GPS latitude and longitude (LL) and time display (when connected to a GPS)
- Choice of High or Low (25 W or 1 W) transmission power
- 5 key handset mic
- Powerful 4 W external audio output
- Access to all currently-available marine VHF channel banks (USA, Canada, International) including weather channels where available (model dependant)
- Special CH16/9 key for quick access to the priority (international distress) channel
- Special 3CH key to select your three favourite channels
- Dedicated Wx (Weather) key
- PSCAN (similar to dual watch) facility
- DSC (Digital Select Calling) capability that meets Global DSC Class D Standards
- Separate CH70 receiver included built in
- DISTRESS call button to automatically transmit the MMSI and position until an acknowledgement is received
- Easy access to a buddy list of up to 20 favourite people
- MMSI storage for three favourite groups
- Group Call and All Ships Call facility
- LL position polling information
- Weather alert facility where available (US models)
- ATIS facility for inland waterways (EU models)
- With DSC Auto-Switch disable and DSC Test function
- With NMEA 0183 and NMEA 2000 communication ports

1-2 Customizing your Simrad VHF Radio

You can customize the radio to suit your individual preferences. Some preferences can be set directly through the keys as explained in this section. Other preferences are set up through the built-in menus and these are explained in later sections.

You can check the software version of the radio and the User MMSI each time the radio is turned on, the screen will display the software version and the USER MMSI if one is programmed into the radio.

1-3 How to Display and Navigate Menus

1. Press MENU (or CALL). Note that only four menu items can be displayed at any one time on the screen.
2. Some line items may show an ▲ or ▼ indicator. This means there is more information available to show. Use the + / - keys to scroll up and down the menu until the cursor is positioned at the desired option. Press ENT to display that option.
3. Make entries or changes as explained in the following section.
4. Press ENT to confirm changes. Otherwise, press ESC to keep the original entry.
5. Press ESC to backup one screen (this key is equivalent to an ESC function on a PC).

1-4 How to Enter Alphanumeric Data

If your radio does not have the optional alphanumeric microphone, you can use + / - keys to enter alphanumeric data.

- Press - to count through numbers, or hold down to scroll rapidly to the desired number.
- Press + to step through the alphabet, or hold down to scroll rapidly to the desired character.
- If you make an error, press - until < is displayed, then press ENT to backup and correct the entry.

1-5 LCD Symbols and Meanings

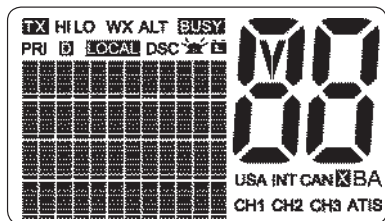

RS12 LCD showing all segments:

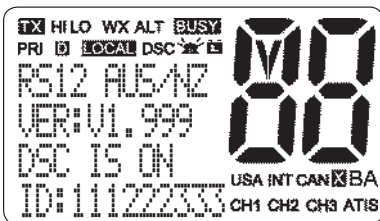

Typical RS12 startup screen:



This simulation shows the locations of all the following information symbols:

Symbol	Meaning
TX	Transmitting.
HI LO	Transmission power. High (HI) 25 W or Low (LO) 1 W.
WX	Weather channel.
WX ALT	Weather Alert. Alarm beeps will sound (US models only).
BUSY	Receiver busy with an incoming signal.
PRI	Priority channel is selected.
D	Duplex operation. Otherwise, blank for Simplex operation.
LOCAL	Local calling is selected. Otherwise, blank for distance calling.
DSC	DSC capability is available.
	Incoming DSC call.
	Low Battery warning (activates at 10.5 V).
	Channel selected.
USA INT CAN	Selected channel bank for VHF radio operations and regulations.
X	DSC Auto channel switch function is disabled (OFF) (see section 4-8)
B A	Channel suffix, if applicable.
CH1 CH2 CH3	Shows which of the 3 favourite channels, if any, are selected. Otherwise blank.
ATIS	EU models only - must be enabled when in European inland waterways.

A typical display:

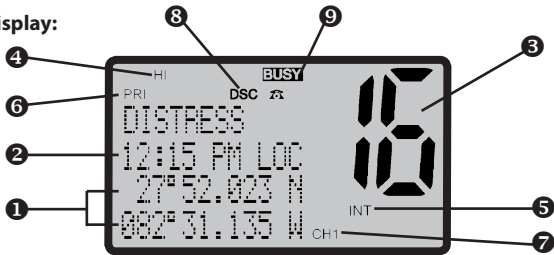

The **latitude and longitude** ① of the vessel and the **local time** ② are shown. A transmission on **Channel 16** ③ is being made at **high power** ④. The **International channel bank** ⑤ is loaded. Channel 16 is set as the **Priority channel** ⑥. It is also set as **favourite channel 1** ⑦. **DSC functionality** ⑧ is enabled. There is an **incoming DSC call** ⑧ so the **receiver is busy** ⑨.

1-6 Basic Operation and Key Functions

All possible keys and their functions are listed here. Note that some of the keys may not be available depending on your Simrad VHF radio model.

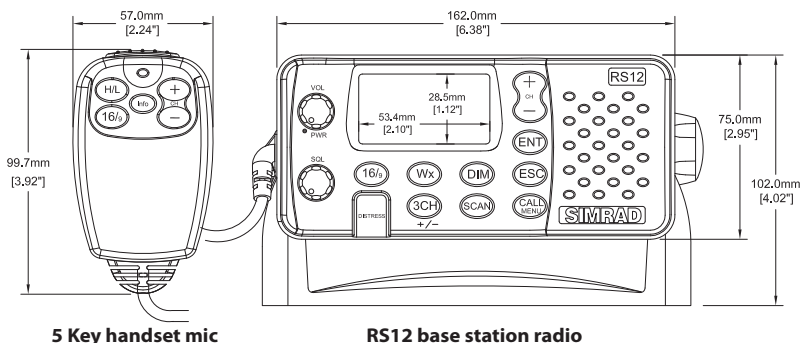

5 Key handset mic

RS12 base station radio

Key: **Function:**

VOL/PWR **Volume and Power**

Turn clockwise to power on. Continue to turn until a comfortable volume is reached. VOL/PWR will also adjust the settings of an external speaker, if connected.

SQL **Squelch or Threshold Level**

Sets the threshold level for the minimum receiver signal. Turn fully counterclockwise until random noise is heard, then turn slowly clockwise until the random noise disappears. Make another 1/4 turn clockwise for best reception in open sea conditions. In areas of high noise (eg. close to large cities) reception may improve if sensitivity is reduced. Either turn SQL slowly clockwise or use the LOCAL setting. See section 2.3.

16 / 9 **Priority Channel**

Also on the handset mic. Press to cancel all other modes and to tune into the priority channel. Press again to return to your original channel. The default Priority Channel is CH16.

For US models: To make Channel 09 the priority channel, hold down 16/9 until a beep sounds and 09 is displayed.

DISTRESS **Send a DSC Distress Call**

DSC must be active and an MMSI must be programmed. See Section 6.

PTT **Press To Talk**

(Located on the handset mic). Press PTT to transmit at any time on an allowable channel. This automatically exits you from menu mode and stops scanning. You must release PTT to receive a signal.

If PTT sticks, a built-in timer will automatically shut down a transmission after five minutes and sound a short error beep.

ENT	<p>Enter (ENT) Use ENT when navigating menus, to confirm entries and edits.</p>
ACCEPT	<p>Received DSC Call mode: Press to change immediately to the requested channel.</p>
OPT	<p>Received Individual Call mode: Press to view any incoming individual call reply options.</p> <p>Send DISTRESS Call mode: Press to view and select any available options.</p>
ACK	<p>Receive Individual Call, LL Request, DSC Test Call, or Distress relay (US only) mode: Press to acknowledge an incoming call when an ACK is requested.</p>
ESC	<p>Escape (ESC) Use ESC when navigating menus, to clear incorrect entries, to exit from a menu without saving changes, and to back up to the previous screen.</p>
QUIT	<p>DSC Call mode only: Press to return to the previous screen.</p>
CALL	<p>DSC Call Menu Press to enter the DSC Call Menu and make DSC calls. See Section 6.</p>
RESEND	<p>DISTRESS CALL mode only: Press to resend a distress alert again.</p>
MENU	<p>Radio and DSC Setup Menu Press to enter the DSC Setup Menu and to customize your radio. See Section 4.</p>
WX	<p>Weather Channel. For US models: In USA and Canadian waters, press to hear the most recently selected weather station. The WX symbol is displayed on the LCD. Press + / - to change to a different weather channel. Press WX again to return to the most recent channel. If the weather alert mode (ALT) is ON and an alert tone of 1050 Hz is broadcast from the weather station, it is picked up automatically and the alarm sounds. Press any key to hear the weather alert voice message.</p> <p>For all other models: The WX key can be programmed to a weather channel of your choice. Select a channel you wish to use as your weather channel, then press and hold the WX key for a few seconds. The radio will beep to confirm your choice. You now have quick access to your favourite channel by pressing the WX key.</p>
INFO	<p>DISTRESS CALL mode only: Press to review distress call information.</p>
3CH	<p>Three Favourite Channels Also on the handset mic. Press to toggle between your favourite channels. The CH1, CH2, or CH3 symbol appears on the LCD to show which favourite channel is selected.</p> <p>To scan only one of your favourite channels, press 3CH then immediately press and release SCAN. If you want to scan all three favourite channels, press 3CH then immediately press and hold SCAN.</p> <p>To add a favourite channel for the first time, select that channel then hold 3CH to store it in the CH1 location. Repeat the procedure to store two more favourite channels in the CH2 and CH3 locations respectively.</p> <p>If you try and add another favourite channel it will overwrite the existing CH3. CH1 and CH2 remain unless you delete them.</p> <p>To delete a favourite channel, select that channel then hold down 3CH until the CH1, CH2 or CH3 symbol disappears off the LCD.</p>

PAUSE **DISTRESS CALL mode only:** Pause the automated distress alert resend countdown timer.

SCAN **Scan**
Press to scan between your current channel and the priority channel in **DUAL** or **TRI WATCH** mode. The weather channel is also scanned if the USA channel bank is selected and the weather alert mode (ALT) is ON.

Hold down SCAN to enter **ALL SCAN** mode where the priority channel is checked every 1.5 seconds.

When a signal is received, scanning stops at that channel and **BUSY** appears on the screen. If the signal ceases for more than 5 seconds, the scan restarts.

Press ENT to temporarily skip over (lock out) an "always busy" channel when in ALL SCAN mode and resume the scan. If a channel is skipped, the word 'SKIP ON' will momentarily replace the channel name shown on the LCD to designate a skipped channel. The channel name will then have ' *' appended to the end of the channel name. Note that it is not possible to skip over the priority channel.

To cancel a skipped channel, select the channel while in normal mode (non-scan mode) then press the ENT key - 'SKIP OFF' will be displayed momentarily and the channel will be restored. Alternatively, you can re-power the radio.

Press SCAN to stop at the current channel.

Press ESC to cancel scan mode and return to normal operation.

DISTR. CANCEL **DISTRESS CALL mode only:** Press to send a distress cancel call.

CH + / - **Channel Select**

Also located on the handset mic. The current channel is shown on the screen in BIG digits with an appropriate designator suffix A or B in small letters below the channel number (if applicable).

Press + or - to step through the available channels one at a time, or hold down to scroll rapidly through all the available channels.

See Appendix C for a complete listing of channel charts.

Alphanumeric Entry

This key can be used for both menu selection and for alphanumeric entry. Press + or - to scroll the cursor up or down to menu options when navigating menus.

When editing an item containing only numbers, press - to count through the numbers or hold down to scroll rapidly.

To enter a character, press + to step through the alphabet or hold down to scroll rapidly.

SILENCE **DSC Call mode only:** Press + or - key to silence the call alert when a DSC call is received.

DIM **Dim**
Press to Dim the LCD and keypad lighting. There are 8 levels from OFF to full brightness.

H/L

Transmission Power

(Located on the handset mic). High (HI) 25 W or Low (LO) 1 W. Press to toggle between high or low transmission power for the entire channel bank. The HI or LO selection is shown on the LCD.

Some channels allow only low power transmissions. Error beeps will sound if the power transmission setting is incorrect.

Some channels allow only low power transmissions initially, but can be changed to high power by holding down H/L and PTT at the same time.

See Appendix C for a complete listing of channel charts.

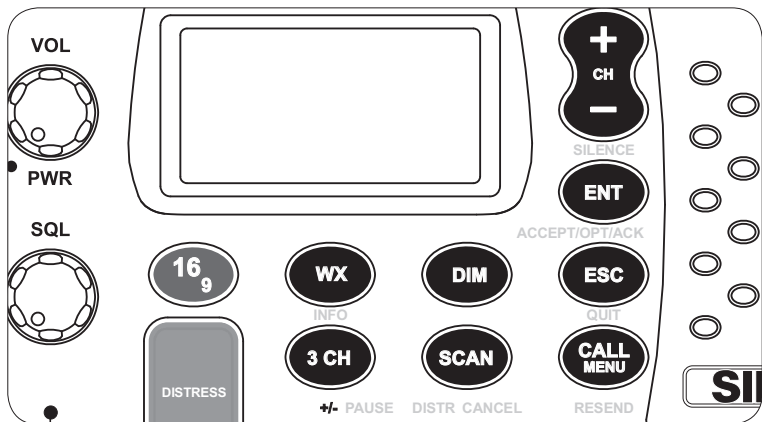

Close-up of the RS12 base station radio, showing the keys

Section 2 - The Radio Menu (MENU)

2-1 Radio Menu Options (Menu)

The following options are available through MENU key:

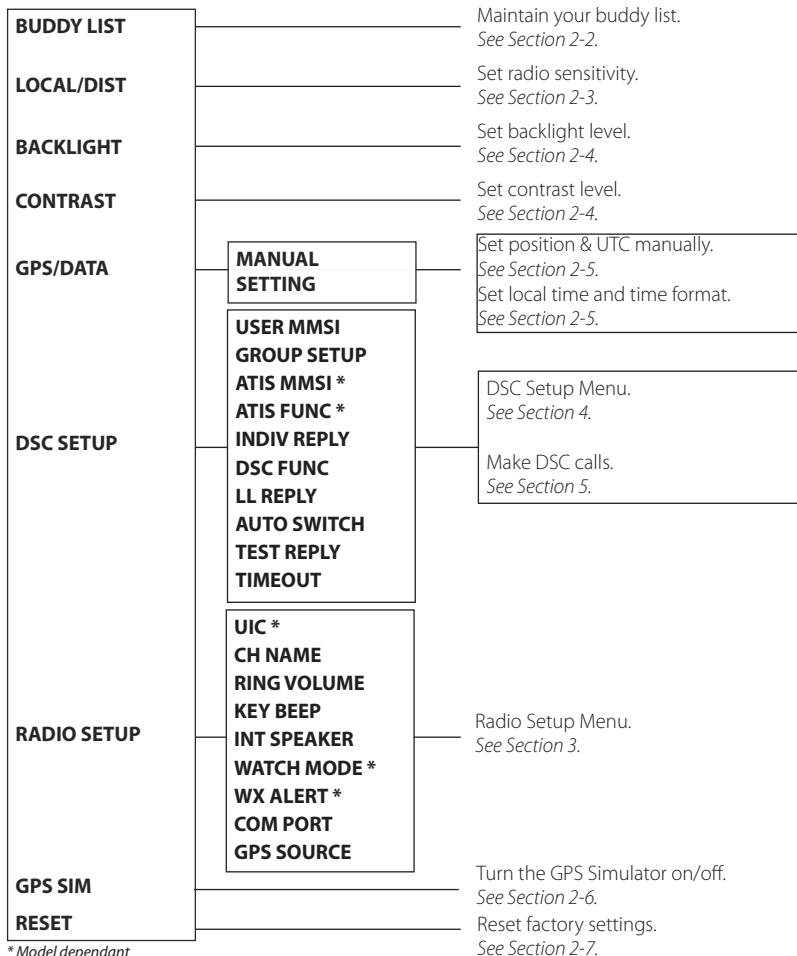

* Model dependant

Sections 1-3 and 1-4 explain how to navigate around the menu and enter, save and change data.

2-2 Maintain Your Buddy List (BUDDY LIST)

```
MENU SELECT
▶BUDDY LIST
LOCAL/DIST
BACKLIGHT ▼
```

Use the Buddy List to store the names and associated MMSI's of 20 favourite people. Names are stored in the order of entry, with the most recent entry shown first.

The following sections show how to add, edit, and delete entries on your BUDDY LIST. Section 5 explains how to call a buddy.

2-2-1 Add an Entry

```
BUDDY LIST
▶MANUAL NEW
ALEX
TOM
```

```
ENTER NAME
-----
ENTER MMSI
-----
```

```
ENTER NAME
BOB
ENTER MMSI
123456789
```

```
BOB
123456789
▶STORE
CANCEL
```

1. Select BUDDY LIST. The cursor is at MANUAL NEW. Press ENT.
2. Enter the buddy name, one character at a time (this may be alphanumeric) then press ENT repeatedly until the cursor moves to the MMSI entry line.
3. Enter the MMSI associated with that buddy name (this must be numeric) then press ENT. If the MMSI is for a Coast Station, enter the 7 digits then press ENT twice.
4. The new buddy name and MMSI are displayed. Press ENT to store the new entry, which is displayed at the top of your buddy list.

Note: When the BUDDY LIST is full (20 entries), you can make a new entry and the buddy at the end of the list is automatically erased.

2-2-2 Edit an Entry

```
BUDDY LIST
▶MANUAL NEW
ALEX
TOM
```

```
ALEX
▶EDIT
DELETE
```

```
EDIT NAME
ALEX
EDIT MMSI
112233445
```

```
ALEX
111223344
▶STORE
CANCEL
```

1. Select BUDDY LIST. Press ENT to display the list of entries.
2. Scroll down (if required) to the entry and press ENT.
3. Select EDIT. The cursor is at the first character of the name.
4. Edit the buddy name or, to edit only the MMSI, press ENT repeatedly until the cursor moves to the MMSI line.
5. When you are finished, press ENT (repeatedly if necessary) to display the next screen.
6. Press ENT to store the changes. The buddy list is displayed again. If more changes are required, repeat Steps 2 through 6. Otherwise, press ESC to cancel.

2-2-3 Delete an Entry

```
BUDDY LIST
▶MANUAL NEW
ALEX
TOM
```

```
BUDDY LIST
MANUAL NEW
ALEX
▶TOM
```

```
TOM
EDIT
▶DELETE
```

```
DELETE BUDDY
TOM
▶YES
NO
```

1. Select BUDDY LIST. Press ENT to display the list of entries.
2. Scroll down (if required) to the entry you want to delete and press ENT.
3. Select DELETE then select YES.
4. The entry is deleted immediately and the buddy list is displayed again.

2-3 Local or Distance Sensitivity (LOCAL/DIST)

```
MENU SELECT
BUDDY LIST
▶LOCAL/DIST
BACKLIGHT ▼
```

Use LOCAL/DIST to improve the sensitivity of the receiver either locally (LOCAL) or over distances (DIST).

LOCAL is not recommended for use in open sea conditions. It is designed for use in areas of high radio noise; for example, close to cities.

See also SQL (Squelch Control) in Section 1-6.

2-3-1 Set DISTANT Sensitivity

```
SENSITIVITY
▶DISTANT
LOCAL
```

1. Select LOCAL/DIST then select DIST.
2. Press ENT to activate the DIST setting. This disables local sensitivity and the menu is displayed again.

2-3-2 Set LOCAL Sensitivity

```
SENSITIVITY
DISTANT
▶LOCAL
```

```
PRI 1000 DGC
MENU SELECT
>BUDDY LIST
LOCAL/DIST
BACKLIGHT ▼
```



1. Select LOCAL/DIST then scroll to LOCAL.
2. Press ENT to activate the LOCAL setting. This disables distance sensitivity and the menu is displayed again.

LOCAL is displayed on the LCD as a reminder that local sensitivity is selected.

2-4 Backlighting (BACKLIGHT) and Contrast (CONTRAST)

```
MENU SELECT
LOCAL/DIST ▲
▶BACKLIGHT
CONTRAST ▼
```

Use BACKLIGHT to set the backlight levels for the LCD, keypad and microphone keypad to a comfortable level.

Use CONTRAST to set the contrast level for the LCD.

2-4-1 Set the Backlighting Level



1. Select BACKLIGHT.
2. Select a comfortable backlight level using + or - to change the setting.
3. Press ENT to enable the setting and return to the menu.

Note: The DISTRESS key backlighting cannot be switched off.

2.4.2 Set the Contrast Level



1. Select CONTRAST.
2. Select a comfortable contrast level using + or - to change the setting.
3. Press ENT to enable the setting and return to the menu.

2-5 GPS Data and Time (GPS/DATA)

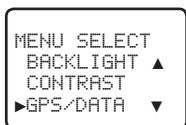

If the boat has an operational GPS navigation receiver, the VHF radio automatically detects and updates the vessel position and the local time.

However, if the GPS navigation receiver is disconnected or absent, you can specify the vessel position and the local time manually, using the GPS/DATA option.

This information is important because it will be used if a DSC distress call is transmitted.

You can also select GPS Alert and GPS Simulator options.

2-5-1 Manually Enter Position and UTC Time (MANUAL)

Note that this function is available only if an operational GPS receiver is not connected.

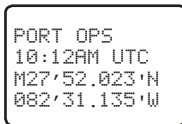
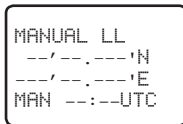
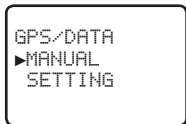

1. Select GPS/DATA, then MANUAL.
2. Enter the latitude, then the longitude, then the UTC.
3. Press ENT when all the information is correct.

The vessel's latitude and longitude are shown on the screen, with the UTC time. The prefix M indicates a manual entry. The manual entries are cancelled if a real GPS position is received.

2-5-2 Local Time (TIME OFFSET)

The local time can be set by entering the time offset between UTC and local time as follows.

```
GPS/DATA
MANUAL
▶SETTING
```

```
SETTING
▶TIME OFFSET
TIME FORMAT
TIME DISPL▼
```

```
TIME OFFSET
▶+01:30
02:30PM LOC
```

1. Select GPS/DATA, then SETTING.
2. Select TIME OFFSET to enter the difference between UTC and local time. 15 minute increments can be used with a maximum offset of ± 13 hours.

In this example, a difference of +1.5 hours has been entered and the local time is displayed with the suffix LOC.

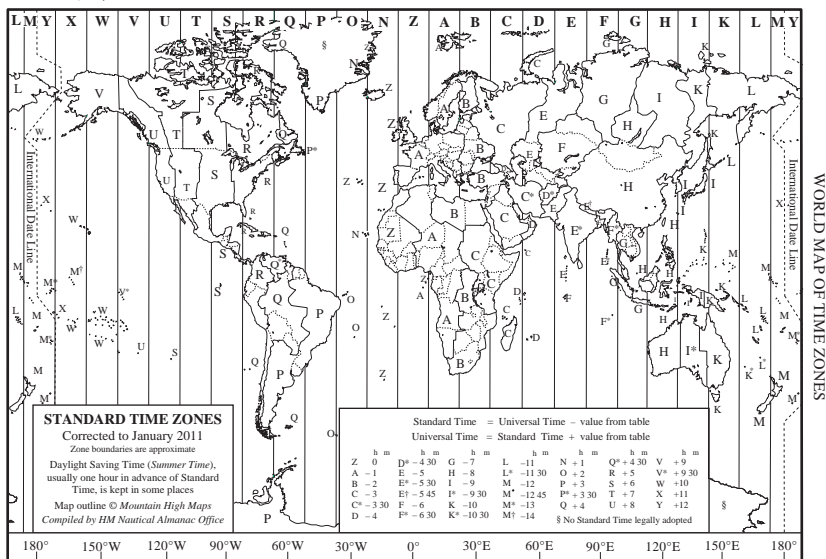

2-5-3 Time Format Options (TIME FORMAT)

Time can be shown in 12 or 24 hour format.

```
GPS/DATA
MANUAL
▶SETTING
```

```
SETTING
TIME OFFSET
▶TIME FORMAT
TIME DISPL▼
```

```
TIME FORMAT
▶12 Hr
24 Hr
07:15AM LOC
```

1. Select GPS/DATA, then SETTING.
2. Select TIME FORMAT.
3. Select 12 Hr or 24 Hr as desired. In this example, 12 hour format has been selected and the LCD shows the AM or PM suffix.

2-5-4 Time Display Options (TIME DISPLAY)

If you have entered the time manually, as described in the previous sections, the time is always shown on the screen with the prefix M.

However, if the vessel position is being updated through a GPS navigation receiver, you can switch the time display on the screen ON or OFF as follows:

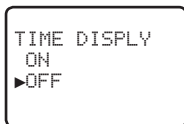
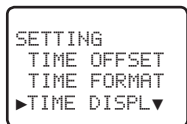

1. Select GPS/DATA, then SETTING.
2. Select TIME DISPLAY.
3. Select ON (on) or OFF (off) as desired. In this example, OFF has been selected and the screen no longer shows the time.

If the time display is set ON, course and speed data are not displayed on the LCD (see section 2-5-6).

2-5-5 Position Display Options (LL display)

If you have entered the vessel position manually, as described in the previous section, the vessel position is always shown on the screen with the suffix M.

However, if the time is being updated through a GPS navigation receiver, you can switch the vessel position display on the screen on or off as follows:

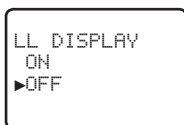
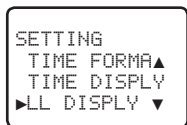

1. Select GPS/DATA, then SETTING.
2. Select LL DISPLAY.
3. Select ON (on) or OFF (off) as desired. In this example, OFF has been selected and the screen no longer shows the vessel position.

2-5-6 Course & Speed Display Options (COG/SOG)

Use this option to display course over ground (COG) and speed over ground (SOG) data on the screen.

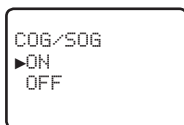
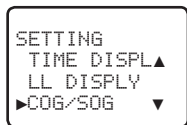

1. Select GPS/DATA, then SETTING.
2. Select COG/SOG.
3. Select ON (on) or OFF (off) as desired. In this example, ON has been selected and the screen shows the bearing and speed.

If COG/SOG is set ON (on), the time is not displayed on the screen (see section 2-5-4).

2-5-7 GPS Alert Options (ALERT)

The GPS alert is usually set to ON (on) so that if the GPS navigation receiver is disconnected, the alarm sounds.

```
SETTING
LL DISPLY ▲
COG/SOG
▶GPS ALERT
```

```
GPS ALERT
▶ON
OFF
```

1. Select GPS/DATA, then SETTING.
2. Select GPS ALERT.
3. Select ON (on) or OFF (off) as desired.

2-6 GPS Simulator (SIMULATOR)

The GPS Simulator is set to OFF whenever the radio is switched ON, or whenever real GPS data is available through the COM port. However, if you want to test it, turn it on.

```
MENU SELECT
DSC SETUP ▲
RADIO SETUP
▶GPS SIM ▼
```

1. Select GPS SIM, then select ON (on) or OFF (off) as desired.

Whenever the GPS Simulator is turned ON (on), simulated Speed Over Ground (SOG), Course Over Ground (COG), and LL position appear on the screen. This data is updated automatically during the simulation.

Important: It is not possible to send a DSC transmission when in Simulator mode.

2-7 Reset to Factory Defaults (RESET)

Use this setting to return every setting to the factory defaults, except all MMSI settings, entries in your buddy list and any edited channel names.

```
MENU SELECT
RADIO SETU▲
GPS SIM
▶RESET
```

```
RESET RADIO
ARE YOU SURE
▶YES
NO
```

1. Select RESET. The radio asks for confirmation.
2. Select YES to reset the radio and return to the menu.

Section 3 - Radio Setup Menu (RADIO SETUP)

3-1 Radio Setup Menu (RADIO SETUP)

The following options are available through the MENU key:

UIC *	Channel band. <i>See Section 3-2.</i>
CH NAME	Edit or delete channel names. <i>See Section 3-3.</i>
RING VOLUME	Set the volume level of the incoming call notification beeps. <i>See section 3-4.</i>
KEY BEEP	Set the volume level of the beeps. <i>See section 3-4.</i>
INT SPEAKER	Switch ON/OFF (on/off) the radio's internal speakers. <i>See section 3-5.</i>
WATCH MODE *	Selects Priority Channel operation with Dual or Tri watch scanning. <i>See section 3-6.</i>
WX ALERT *	Selects if the WX Alert scanning mode is ON (on) or OFF (off). <i>See section 3-7.</i>
COM PORT	Select NMEA protocol for communications between the VHF radio and any other instruments. <i>See section 3-8.</i>
GPS SOURCE	Select NMEA 0183 or NMEA 2000 source to receive GPS data <i>See section 3-9.</i>

* Model dependant

Sections 1-3 and 1-4 explain how to navigate around the menu and enter, save and change data.

3-2 Channel (UIC)

Note: UIC may not be available on all models.

Toggle between USA, International or Canadian channel banks. The selected channel bank is displayed on the LCD along with the last used channel. All the channel charts are shown in Appendix C.

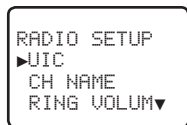

3-3 Channel Names (CH NAME)

The channel charts are listed in Appendix C with their default name tags. CH NAME gives you the option to edit or delete the channel name tags displayed on the screen.



1. Select RADIO SETUP, then CH NAME.
2. Use + or - to step through the channels with their name tags until you see the channel name tag you want to change, then press ENT. In this example, the channel name TELEPHONE associated with channel 01 is being changed to PHONE1.
3. Select EDIT and press ENT to edit the existing name tag. Input the CH name over the existing name. It can be a maximum of 12 characters.

To delete the channel name, select DELETE and press ENT.

4. Press ENT (repeatedly if necessary) to display the YES/NO confirmation.
5. Press ENT to confirm the new channel name tag or the deletion, then press ESC to return to the menu.

3-4 RING & BEEP Volume (RING VOLUME) and (KEY BEEP)

Set the volume level of the incoming signal beeps (RING VOLUME) and/or the error and warning beeps (KEY BEEP) to HIGH (high) or LOW (low) as follows:

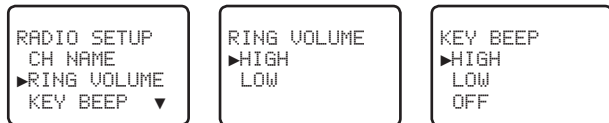

1. Select RADIO SETUP, then RING VOLUME or BEEP VOLUME as appropriate.
2. Select a HIGH or LOW volume. (It is possible to turn the beeps off completely by selecting KEY BEEP then OFF.)
3. Press ENT to enable the new volume setting and return to the menu.

3-5 Internal Speaker Connections (INT SPEAKER)

Switch the radio's internal speaker ON (on) or OFF (off). The external speaker is always ON (on) if a speaker is plugged into the external speaker jack.

```
RADIO SETUP
RING VOLUM▲
KEY BEEP
▶INT SPEAKE▼
```

```
INT SPEAKER
▶ON
OFF
```

1. Select RADIO SETUP, then INT SPEAKER.
2. Select ON (on) or OFF (off) then press ENT to enable the setting and return to the menu.

3-6 Set the Priority Channel (WATCH MODE)

For EU models, watch mode is similar to a dual watch, scanning between the priority channel CH16 and the working channel. If you have US model and are operating on USA or Canadian channel banks, you can set the priority channel to cover both CH16 and CH09 as well as the working channel, as follows:

```
RADIO SETUP
KEY BEEP ▲
INT SPEAKER
▶WATCH MODE▼
```

```
WATCH MODE
▶ONLY 16CH
16CH+9CH
```

1. Select RADIO SETUP, then WATCH MODE.
2. Select ONLY 16CH for dual watch mode, or 16CH+9CH for tri watch mode.

3-7 Weather Alert (Wx ALERT)

US models ONLY

The NOAA provides several weather forecast channels on USA and Canadian channel banks. If severe weather such as storms or hurricanes are forecast, the NOAA broadcasts a weather alert on 1050 Hz. You can set up the radio to pick up weather alerts, as follows:

```
RADIO SETUP
INT SPEAKE▲
WATCH MODE
▶WX ALERT ▼
```

```
WX ALERT
ON
▶OFF
```

1. Select RADIO SETUP, then WX ALERT.
2. Select ON (on) or OFF (off) then press ENT to enable the setting and return to the menu.

When a weather alert is broadcast, the alarm will sound. Press any key to hear the weather alert voice message.

3-8 NMEA protocol (COM PORT)

This radio uses NMEA0183 protocol to receive GPS data from a compatible GPS unit. The COM Port must be configured correctly before use. The radio can be added to a group of instruments using NMEA protocol.

```
RADIO SETUP
WATCH MODE▲
WX ALERT
▶COM PORT
```

```
NMEA
CHECKSUM
▶ON
OFF
```

1. Select RADIO SETUP, then COM PORT.
2. Select CHECKSUM ON (on) or OFF (off) then press ENT to enable the setting and return to the menu.

CHECKSUM ON is the default setting.

The COM Port uses 4800 baud rate and can receive the following GPS data sentence: RMC, GGA, GLL, GNS. Additionally, this radio will output the following NMEA DSC data: DSC (for DSC call), DSE (for enhanced position).

3-9 Select the GPS Source (GPS SOURCE)

This radio can use either NMEA 0183 or NMEA 2000 protocol to receive GPS data from a compatible GPS unit.

Note: NMEA 2000 SOURCE options will appear - up to 4 sources showing the actual source name - only if connected to an NMEA 2000 network.

```
RADIO SETUP
INT SPEAKE▲
COM PORT
▶GPS SOURCE
```

```
GPS SOURCE
NMEA 0183
▶N55
N5E
```

1. Select RADIO SETUP, then GPS SOURCE.
2. Select the desired NMEA source then press ENT.

If there is only one NMEA protocol available on your vessel, only that will be shown.

Section 4 - DSC Setup Menu (DSC SETUP)

WARNING

A valid USER MMSI must be entered into this radio before these DSC functions can be used. See below for instructions on how to enter your USER MMSI (USER MMSI).

4-1 DSC Setup - Menu Options

The following options are available through the MENU key:

USER MMSI	Enter or view your user MMSI. <i>See section 4-2.</i> (If you do not have a user MMSI, see Appendix D.)
GROUP SETUP	Enter or change the name and/or details of a group. <i>See section 4-3.</i>
ATIS MMSI *	Enter, change or view your ATIS MMSI. <i>See section 4-5.</i>
ATIS FUNC *	Enable/disable the ATIS function. <i>See section 4-5-3.</i>
INDIV REPLY	Choose an automatic or manual response to calls. <i>See section 4-4.</i>
DSC FUNC	Turn the DSC operation ON/OFF (on/off). <i>See section 4-6.</i>
LL REPLY	Select the type of response to an LL polling request. <i>See section 4-7.</i>
AUTO SWITCH	Enable/disable automatic channel switching with DSC message <i>See section 4-8.</i>
TEST REPLY	Choose an automatic or manual response to DSC test call. <i>See section 4-9.</i>
TIMEOUT	Set the inactivity timer for Automated and Non-Automated items. <i>See section 4-10.</i>

* Model dependant

4-2 Enter or View Your USER MMSI (USER MMSI)

You must enter your user MMSI before you can access the DSC functions. This is a **once-only operation**.

4-2-1 Enter your MMSI

You can display and read your user MMSI at any time, but you get only one opportunity to enter your user MMSI. Contact Simrad if you need to change your MMSI after initial input.

```
DSC SETUP
▶USER MMSI
GROUP SETUP
INDIV REPLY▼
```

```
INPUT USER
MMSI
-----
```

```
USER MMSI
187654321
▶STORE
CANCEL
```

```
USER MMSI
INPUT AGAIN
-----
```

1. Select DSC SETUP, then USER MMSI.
2. If this is the **first time** that you are entering your user MMSI, a dashed line appears.
Enter your user MMSI along the dashed line using the +/- keys as described in Section 1-4. Press ENT to confirm each correct entry and to move to the next digit. If you make an error, press - until < appears, then press ENT to backup and correct the entry.
3. Press ENT to store your user MMSI.
4. You may need to enter your user MMSI again as a password check, then press ENT to permanently store the user MMSI and return to the menu.

4-2-2 View your MMSI

You can view your stored user MMSI at anytime by selecting MMSI/GPS in the CALL menu.

```
WARNING
NO MMSI
DSC DISABLED
ENT>>SILENCE
```

Alternatively, the user MMSI is displayed each time the radio is turned on.

If a user MMSI is not programmed into the radio, the radio will display a warning and sound an audible alarm at startup, warning you that all DSC functions are disabled (model dependant).

4-3 Maintain Your Groups (GROUP SETUP)

Use GROUP SETUP to create, edit, or delete 1, 2, or 3 groups of frequently called people stored in alphanumeric order. A group MMSI always starts with 0.

4-3-1 Create a Group (GROUP SETUP)

```
DSC SETUP
USER MMSI
▶GROUP SETUP
INDIV REPL▼
```

```
GROUP SETUP
▶MANUAL NEW
000000000
```

```
GROUP NAME
-----
GROUP MMSI
0-----
```

```
FISHER1
012345678
▶STORE
CANCEL
```

1. Select DSC SETUP, then GROUP SETUP.
2. If this is the **first time** that you are entering a group name, a line of nine zeros appears. Otherwise, any existing group names are displayed. Press ENT to display the input screen.
3. Enter the group name along the dashed line. It can be alphanumeric. Press ENT to confirm each correct entry and to move to the next digit. When you have finished, press ENT repeatedly until the cursor moves to the MMSI line.
If you make an error, press - until < appears, then press ENT to back up and correct the entry.
4. Enter the group MMSI. Note that the first number is always 0. Press ENT.
5. The group name and group MMSI are shown in a confirmation screen. Press ENT to store the details and return to the GROUP SETUP screen.

4-3-2 Edit Group Name Details

```
GROUP SETUP  
MANUAL NEW  
▶FISHER1  
FRIENDS1
```

```
FISHER1  
▶EDIT  
DELETE
```

```
EDIT NAME  
FISHER1  
EDIT MMSI  
012345678
```

```
FISHER2  
012345678  
▶STORE  
CANCEL
```

1. Select DSC SETUP, then GROUP SETUP. The existing group names are displayed. Press + or - to scroll to the incorrect entry then press ENT.
2. Press ENT to edit. The group name details are displayed, with the cursor at the first character of the name.
3. Edit the buddy name or, to edit only the MMSI, press ENT repeatedly until the cursor moves to the MMSI line.
4. When you are finished, press ENT (repeatedly if necessary) to display the next screen.
5. Press ENT to store the changes and return to the GROUP SETUP screen.

4-3-3 Delete a Group

```
GROUP SETUP  
MANUAL NEW  
▶FISHER2  
FRIENDS1
```

```
FISHER2  
EDIT  
▶DELETE
```

```
DELETE GROUP  
FISHER2  
▶YES  
NO
```

1. Select DSC SETUP, then GROUP SETUP. The existing group names are displayed.
2. Press + or - to scroll to the incorrect entry then press ENT.
3. Select DELETE and press ENT. The radio asks for confirmation.
4. Press ENT to delete the group and return to the GROUP SETUP screen.

4-4 Response to Individual Calls (INDIV REPLY)

You can respond to incoming individual calls with an automatic response or with a manual response. Note - this does not apply for Routine Calls.

- An AUTOMATIC response sends an acknowledgement and then sets the request link channel, ready for a conversation after 10 seconds of receiving the call. USA default.
- A manual response asks if you want to acknowledge the call, and then asks if you want to converse with the caller. This is the default setting for EU models.

```
DSC SETUP  
USER MMSI  
GROUP SETUP  
▶INDIV REPLY▼
```

```
INDIV REPLY  
▶MANUAL  
AUTO
```

1. Select DSC SETUP, then INDIV REPLY.
2. Select AUTO for an automatic response, or MANUAL for a manual response.

3. Press ENT to confirm your choice and return to the menu.

4-5 ATIS MMSI & ATIS Functionality

EU models ONLY

ATIS is only available in certain EU models. You must enter your ATIS MMSI to access ATIS functionality. ATIS must be used if you are navigating inland waterways within Europe. An ATIS MMSI is different to your DSC MMSI.

ATIS sends a digital message each time that you release the PTT key. Inland waterways rules require 1 W Tx power on Channels 06, 08, 10, 11, 12, 13, 14, 15, 17, 71, 72, 74 and 77.

4-5-1 Enter or Edit YOUR ATIS MMSI

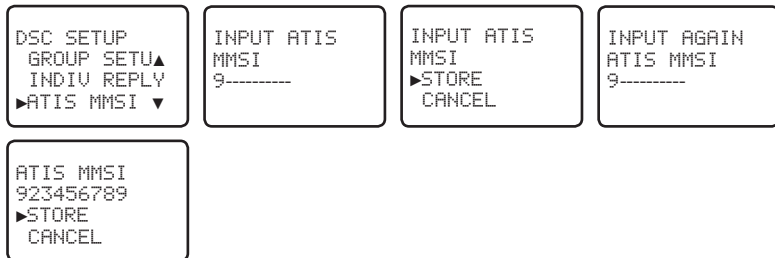

Note: An ATIS MMSI always starts with the number 9.

1. To enter or edit your ATIS MMSI:
2. Select DSC SETUP, then ATIS MMSI.
3. If this is the first time that you are entering your ATIS MMSI, a dashed line appears. Enter your ATIS MMSI along the dashed line using the +/- keys as described in Section 1-4. The first number is always 9. Press ENT to confirm each correct entry and to move to the next digit.

If you make an error, press - until < appears, then press ENT to backup and correct the entry. If you are editing an existing ATIS MMSI, this will be displayed. Make the required changes.
4. Press ENT to store your user ATIS MMSI.
5. You may need to enter your ATIS MMSI again as a password check, then press ENT to permanently store the ATIS MMSI and return to the menu.

4-5-2 View your ATIS MMSI

You can view your stored ATIS MMSI at anytime by selecting ATIS MMSI in the main menu, DSC SETUP.

4-5-3 Enable ATIS Functionality (ATIS FUNC)

ATIS functionality can only be activated if an ATIS MMSI has been entered. See 4-5-1.

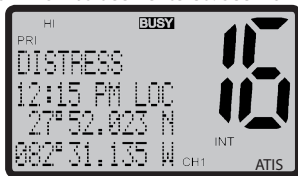
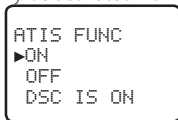

1. Select DSC SETUP, then ATIS FUNC.

Note: It is not possible to have both ATIS ON (on) and DSC ON (on) simultaneously. If you want to activate ATIS, you must first switch DSC off. A note on the LCD will remind you if DSC is already ON.

2. Select ON to enable the ATIS functionality - DSC must be turned off first. The **ATIS** annunciator appears on the screen.

4-6 DSC functionality options (DSC FUNC)

DSC functionality can be disabled but this is not recommended unless you are going to turn ATIS on.

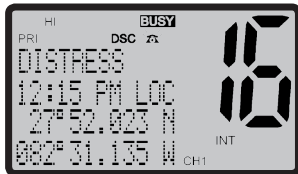
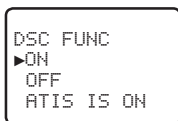
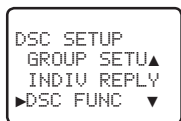

1. Select DSC SETUP, then DSC FUNC.

Note: It is not possible to have both ATIS ON (on) and DSC ON (on) simultaneously. If you want to activate DSC, you must first switch ATIS off. A note on the LCD will remind you if ATIS is already ON.

2. Select ON to enable the DSC functionality - ATIS (if applicable) must be turned off first. The **DSC** annunciator appears on the screen.

There are two annunciators on the screen to show you the current mode: if the DSC annunciator is shown, DSC is operational, if the ATIS annunciator is shown, ATIS is operational.

4-7 Response Type to LL Polling Calls (LL REPLY)

You can set the radio to respond to an LL polling request in one of three ways:

- AUTO** automatically replies to any incoming LL polling requests from any of your buddies.
- MANUAL** choose to manually reply to any incoming buddy polling requests.
- OFF** ignores all incoming buddy LL polling requests.

```
DSC SETUP
INDIV REPL▲
DSC FUNC
▶LL REPLY ▼
```

```
LL REPLY
MANUAL
▶AUTO
OFF
```

1. Select DSC SETUP, then LL REPLY.
2. Select your response and press ENT to confirm and return to the menu.

4-8 Automatic Channel switching (AUTO SWITCH)

When a DSC call is received, it may include a request to change to a specific channel for subsequent communications. If a channel switch request is included, your options are:

- allow the radio to switch to the requested channel immediately by pressing the ENT button, or
- do nothing to allow the radio to automatically switch to the requested channel after a delay of 10 seconds, or
- cancel the automatic switch and remain on the current channel by pressing the ESC button.

However, automatic switching to a subsequent communications channel on receipt of a DSC call might in some cases disrupt important ongoing communications if the working channel changes without the operator knowing.

You can prevent the radio from automatically switching from the current working channel by setting the AUTO SWITCH feature to OFF.

If the AUTO SWITCH feature is set to OFF, an **X** will be displayed on the LCD to remind you that this feature is set to off. Additionally, the text "AUTO SW OFF" will be included in an All Ships or Group call replacing the text "AUTO CHxx"

```
DSC SETUP
DSC FUNC ▲
LL REPLY
▶AUTO SWITC▼
```

```
AUTO SWITCH
▶ON
OFF
```

1. Select DSC SETUP, then AUTO SWITCH.
2. Select ON (on) to enable automatic channel switching.
3. Select OFF (off) to disable automatic channel switching.

4-9 DSC Test Reply (TEST REPLY)

You can respond to incoming DSC TEST calls with an automatic response or with a manual response.

- MANUAL** manual response is required, press ENT to confirm or press ESC to cancel.
- AUTO** automatically replies after a 10 second delay with an ACK to any incoming DSC TEST call.

```
DSC SETUP
LL REPLY ▲
AUTO SWITCH
▶TEST REPLY▼
```

```
TEST REPLY
▶MANUAL
  AUTO
```

4-10 Set the inactivity timer (TIMEOUT)

You can set the inactivity timer with the following options:

AUTOMATED you can set the inactivity timer to automatically timeout after a period of inactivity for the following two categories: NON-DISTRESS or DISTRESS
Timeout options are:

DISTRESS: NO TIMEOUT; 5 MINS; 10 MINS (default is NO TIMEOUT)

NON-DISTR: NO TIMEOUT; 10 MINS; 15 MINS (default is 15 MINS)

NON AUTO you can set the inactivity timer to exit any non-automated procedure activity. Timeout options are:

NO TIMEOUT; 10 MINS; 15 MINS (default is 10 MINS)

Note: If NO TIMEOUT is selected, then you must press the ESC key to exit the procedure.

Example: to set a 10 minute TIMEOUT for non-automated functions:

1. Select TIMEOUT, then select NON AUTO
2. Select desired timeout period: NO TIMEOUT, 10 MINS or 15 MINS

```
DSC SETUP
AUTO SWITCH▲
TEST REPLY
▶TIMEOUT
```

```
TIMEOUT
AUTOMATED
▶NON AUTO
```

```
NON AUTO
NO TIMEOUT
▶10 MINS
  15 MINS
```

In this example, 10 MINS has been selected, meaning the radio will exit any non-automated procedure after a period of 10 minutes of non-activity.

Section 5 - Sending and Receiving DSC Calls

WARNING

A valid USER MMSI must be entered into this radio before these DSC functions can be used. See 4-2 Enter Your USER MMSI (USER MMSI).

5-1 What is DSC?

DSC (Digital Selective Calling) is a semi-automated method of establishing VHF, MF, and HF radio calls. It has been designated as an international standard by the IMO (International Maritime Organization) and is part of the GMDSS (Global Maritime Distress and Safety System).

Currently, you are required to monitor the VHF Distress Channel 16, but DSC will eventually replace listening watches on distress frequencies and will be used to broadcast routine and urgent maritime safety information.

DSC enables you to send and receive calls from any vessel or coast station that is equipped with DSC functionality, and within geographic range. Calls can be categorised as distress, urgency, safety, or routine, and DSC selects a working channel automatically.

5-2 Sending DSC calls

Press CALL to show the types of DSC call that can be made.

The following options are available through CALL key:

INDIVIDUAL	Make an individual call or acknowledgement to a new caller or a buddy. See Section 5-2-1, 5-2-2, and 5-2-3.
LAST CALL	Show the details of the most recent incoming call. See Section 5-2-4.
GROUP	Make a call to one of your three groups. See Section 5-2-5.
ALL SHIPS	Make an All Ships call. See Section 5-2-6.
CALL LOG	Show the details of the 20 most recent incoming calls. See Section 5-2-7.
DISTR LOG	Show the details of the 10 most recent distress calls. See Section 5-2-8.
SENT CALL	Show the details of the 20 most recent sent calls. See Section 5-2-9.
LL REQUEST	Request the LL position of a buddy. See Section 5-2-10.
DSC TEST	Make a DSC TEST call. See Section 5-2-11.
MMSI/GPS	Show the programmed MMSI and GPS information See Section 4.2.2.

```
DSC CALL
INDIVIDUAL
▶LAST CALL
GROUP ▼
```

Note that only three DSC call types can be shown at any one time on the screen.

Press + or - to scroll up and down the DSC call types until the cursor is positioned at the desired option. Then press ENT. The DSC call types are:

5-2-1 Make a Routine Call (INDIVIDUAL)

You can call any other person that has another DSC equipped radio.

```
DSC CALL
▶INDIVIDUAL
LAST CALL
GROUP ▼
```

```
INDIVIDUAL
▶ROUTINE
SAFETY
URGENCY
```

```
MANUAL MMSI
0-----
```

```
123456789
INDIVIDUAL
ROUTINE
▶INTER-SHIP
```

```
123456789
INDIVIDUAL
ROUTINE
▶SEND?
```

```
123456789
INDIVIDUAL
ROUTINE
CALLING...
```

```
123456789
INDIVIDUAL
ROUTINE
WAIT... 00:00
```

```
INDIVIDUAL
ROUTINE
ACK FROM
▼ 00:00
```

1. Press CALL to enter DSC mode, then select INDIVIDUAL. This allows you to call another person.
2. Press ENT, the arrow is pointing to <ROUTINE>. However, you can select one of the following call priorities: ROUTINE, SAFETY, URGENCY.

To make a Routine call, press ENT to select MANUAL NEW to call a person that is not in your buddy list, otherwise select the name of your buddy. Press ENT.

If you selected MANUAL NEW, you need to enter the user MMSI and then press ENT.

Note: If the MMSI is for a Coast Station, enter the 7 digits then press ENT twice.

3. Select the Inter-ship working channel and press ENT. The radio automatically lists all Inter-ship (Simplex) channels that can be used. (Note: If you wish to use a Duplex channel (Duplex channels cannot usually be called), press + or - until Manual appears, then select your channel of choice. If the call is to a Coast Station (MMSI begins with 00), the radio will recognize this and specify the correct channel to talk on.
4. The radio summarizes the call details and asks for confirmation to send the call (SEND?). Press ENT to send the call. The radio goes to CH70 and the **TX** annunciator is displayed on the screen while the DSC call is being sent.
5. The radio then waits for an acknowledgement and displays the elapsed time since the call was sent.
6. If the call is acknowledged (ACK), press PTT to talk. If there is no reply, retry making the call. See Section 5-2-2.

5-2-2 Retrying a Routine Call

```
123456789
SEND AGAIN?
▶YES
NO
```

1. If there is no reply to your call after 30 seconds (UNABLE TO ACKNOWLEDGE) the radio asks if you want to retry the call (SEND AGAIN?).
2. Select YES and press ENT to retry the call.

The radio will repeat this cycle twice. If the call still cannot be placed, the radio returns to normal operation.

5-2-3 Acknowledgement of an Individual Incoming Call (INDIV)

When an incoming call is received, the alarm sounds for 2 minutes and INDIVIDUAL is displayed.

```
INDIVIDUAL
ROUTINE FROM
123456789
▼ 00:01
```

```
ROUTINE FROM
123456789
CH12 REQUEST
▲▼ 00:02
```

```
123456789
CH12 REQUEST
12:45 UTC
▲▼ 00:03
```

```
CH12 REQUEST
12:45 UTC
ENT->OPTION
▲▼ 00:04
```

```
12:45 UTC
ENT->OPTION
KEY->SILENCE
▲▼ 00:05
```

```
ENT->OPTION
KEY->SILENCE
ESC->EXIT
▲ 00:06
```

```
OPTION
▶ACK
CHANGE CHAN
```

3. Press SILENCE (+ or - CH SELECT) to silence the alarm.
4. Press + or - to scroll any further information about the call
5. Press OPT (ENT) for options on how you want to respond to the call.
Options are:

ACK to acknowledge the call

CHANGE CHAN to acknowledge and request a channel change

UNABLE ACK* respond to the call with unable to use the requested channel
(* Note: this option is not available with ROUTINE calls)

6. Or press QUIT (ESC) to return to standby.

5-2-4 Recall the Most Recent Incoming Call (LAST CALL)

This facility is useful and used frequently.

```
DSC CALL
INDIVIDUAL
▶LAST CALL
GROUP ▼
```

```
BOBBY D
INDIVIDUAL
ROUTINE
10:22 UTC
```

```
BOBBY D
INDIVIDUAL
ROUTINE
▶INTER-SHIP
```

```
BOBBY D
INDIVIDUAL
ROUTINE
▶SEND?
```

1. Press CALL to enter DSC mode. then select LAST CALL. Press ENT to display the contact details of the most recent incoming call.
2. Press ENT to recall the caller. Select the working channel and press ENT. See details about the working channel in section 5-2-1, paragraph 3 above.
3. The radio summarizes the call details and asks for confirmation to send the call (SEND?). Press ENT to send the call, and continue as explained in Section 5-2-1.

5-2-5 Call a Group (GROUP)

```
DSC CALL
INDIVIDUAL
LAST CALL
▶GROUP ▼
```

```
GROUP
▶RD GROUP
GROUP #2
GROUP#3
```

```
RD GROUP
055554444
ROUTINE
▶INTER-SHIP
```

```
RD GROUP
055554444
ROUTINE
▶SEND?
```

1. Press CALL to enter DSC mode, then select GROUP. The radio displays the names of your groups you setup in section 4-3.
2. Select the group that you want to call (the Group MMSI must already be setup).
3. Select the working channel and press ENT. See details about the working channel in section 5-2-1, paragraph 3 above.
4. The radio summarizes the call details and asks for confirmation to send the call (SEND?). Press ENT to send the call, and continue as explained in Section 5-2-1.

5-2-6 Call All Ships (ALL SHIPS)

```
DSC CALL
LAST CALL ▲
GROUP
▶ALL SHIPS ▼
```

```
ALL SHIPS
SAFETY
▶URGENCY
```

```
ALL SHIPS
URGENCY
▶INTER-SHIP
```

```
ALL SHIPS
URGENCY
▶SEND?
```

1. Press CALL to enter DSC mode, then select ALL SHIPS.
2. Select one of the following call priorities:

SAFETY to send safety information to all other vessels in range

URGENCY for use when a serious situation or problem arises that could lead to a distress situation

3. Set the working channel. See details about the working channel in section 5-2-1, paragraph 3 above.
4. The radio then asks for confirmation of the ALL SHIPS call. Press ENT to send the call. Continue as explained in Section 5-2-1.

5-2-7 Call using the Call Log (CALL LOG)

The Call Log contains the contact details for the 20 most recent incoming calls, so that you call any of them again quickly.

```
DSC CALL
GROUP ▲
ALL SHIPS
▶CALL LOG ▼
```

```
01 BOBBY D
INDIVIDUAL
ROUTINE
10:45 UTC
```

```
BOBBY D
▶CALL BACK
DELETE
```

```
BOBBY D
INDIVIDUAL
ROUTINE
▶INTER-SHIP
```

```
BOBBY D
INDIVIDUAL
ROUTINE
▶SEND?
```

1. Press CALL to enter DSC mode, then select CALL LOG. The radio displays the contact details for the most recent incoming call as the first entry (01).
2. Press ENT to advance to next screen.
3. Again press ENT to confirm the call back, then set the working channel. See details about the working channel in section 5-2-1, paragraph 3 above.
4. Press ENT to send the call. Continue as explained in Section 5-2-1.

5-2-8 Call using the Distress Log (DISTR LOG)

The Distress Log contains the Distress Log data for the last 20 relayed Distress Calls so that you can call any of them quickly. Always try to make voice contact on CH16 first, as follows:

```
DSC CALL
ALL SHIPS ▲
CALL LOG
▶DISTR LOG ▼
```

```
01 BOBBY D
DISTRESS
UNDESIG
ENT->OPTION
```

```
BOBBY D
▶CALL BACK
DELETE
INFO
```

```
BOBBY D
INDIVIDUAL
ROUTINE
▶INTER-SHIP
```

```
BOBBY D
INDIVIDUAL
ROUTINE
▶SEND?
```

1. Press CALL to enter DSC mode, then select DISTR LOG. The most recent Distress Call received is the first entry (01) in the Distress Log. Select the entry that you want to call.
2. Press ENT to list OPTION and select one of the following options on how you want to respond to the call:

CALL BACK

to call the station press ENT, then set the channel and continue as explained in Section 5-2-1.

DELETE

to delete the entry from the call log, select YES to confirm.

INFO

to display more information about the station, such as the location and name or MMSI of the vessel in Distress and the nature of the emergency (if specified).

SAVE MMSI

to save the MMSI of the call. You will be asked to add a name of the contact.

5-2-9 Call using the Sent Call Log (SENT CALL)

The Call Log contains the contact details for the 20 most recent sent calls, so that you review details of the call.

```
DSC CALL
CALL LOG ▲
DISTR LOG
▶SENT CALL ▼
```

```
01 BOBBY D
▶INDIVIDUAL
ROUTINE
10:45 UTC
```

```
BOBBY D
▶CALL BACK
DELETE
```

```
BOBBY D
INDIVIDUAL
ROUTINE
▶INTER-SHIP
```

```
BOBBY D
INDIVIDUAL
ROUTINE
▶SEND?
```

1. Press CALL to enter DSC mode, then select SENT LOG. Scroll down to the desired sent call details.
2. The radio displays the details for the most recent sent call as the first entry (01) in the call log. In the example, the contact details for the most recent call are displayed.

3. Press ENT to advance to next screen. You now have the following options:

CALL BACK to CALL the contact.

DELETE to delete the entry from the call log, select YES to confirm.

5-2-10 Request the LL Position of a Buddy (LL REQUEST)

```
DSC CALL
DISTR LOG ▲
SENT CALL
▶LL REQUEST ▼
```

```
LL REQUEST
▶SAM
TOM
BUDDY #3
```

```
SAM
LL REQUEST
▶SEND?
```

```
SAM
LL REQUEST
CALLING...
```

```
SAM
LL REQUEST
WAIT.. 00:17
```

1. Press CALL to enter DSC mode, then select LL REQUEST.
2. Select the buddy whose LL position you want to request then press ENT to send the request. (See Section 5-3-5 for the acknowledgement.)

3. The working channel name is displayed while the radio waits for an acknowledgement from your buddy. If there is no reply after 30 seconds the radio asks if you want to retry. Continue as explained in Section 5-2-2.

5-2-11 Make a DSC test call (DSC TEST)

You can test your radio's DSC operation by sending a DSC TEST CALL to a Buddy or other station equipped with a DSC radio.

Note: You should not use a routine DSC call to test your radio and you should minimize the use of the safety channel for test purposes.

5-2-11-1 Send a DSC TEST call

1. Select DSC CALL then DSC TEST.
2. Select the buddy you want to call from your buddy list, or Select MANUAL NEW then enter the MMSI of the individual you want to call.
3. Press ENT to accept the selection.
4. Press ENT again to SEND the call. Channel 70 is selected automatically and the **TX** symbol is shown on the LCD while the call is being sent.

```
DSC CALL
SENT CALL ▲
LL REQUEST
►DSC TEST ▼
```

```
DSC TEST
MANUAL NEW
SAM
►TOM
```

```
TOM
DSC TEST
►SEND?
```

```
TOM
DSC TEST
WAIT.. 00:17
```

5. The radio waits for an acknowledgement (WAITING ACK). If the call is acknowledged (DSC TEST ACK), notification is displayed.
6. If there is no reply after 30 seconds, the radio asks you if you want to retry.

5-2-11-2 Receiving an incoming DSC TEST call reply (DSC TEST ACK)

```
TEST
ACK FROM
123456789
▼ 00:22
```

1. When you receive notification of a DSC TEST reply, press any key to cancel the alert.
2. If the radio recognizes the user MMSI as one of your buddies, the buddy's name is displayed in place of the user MMSI.
3. Scroll to view further information (if available), or press ESC to cancel.

5-2-11-3 Acknowledging an incoming DSC TEST call

The radio sounds a friendly two-tone alert when it detects an incoming DSC TEST call.

1. If the radio recognizes the MMSI as one of your buddies, your buddy's name is displayed in place of the MMSI.
2. The radio will automatically acknowledge the call if TEST REPLY is set to AUTO (See section 4-9) and after a TIMEOUT period set for AUTO REPLY. (See section 4-10)
3. Scroll to view further information (if available), or press ESC to cancel.

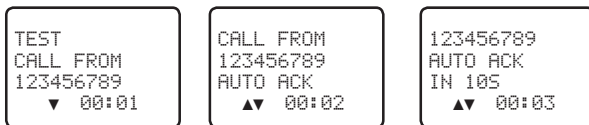

Note: These additional information screens are available by pressing the + and - keys.



4. If TEST REPLY is set to MANUAL, a manual response is required, press ACK (ENT) to confirm or press QUIT (ESC) to cancel. (see Section 4-9)

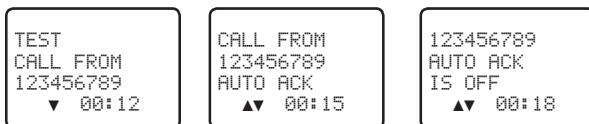

Note: These additional information screens are available by pressing the + and - keys.



5-3 Receiving DSC Calls

Several types of DSC calls can be received from vessels within range at various priority levels:

DISTRESS	See Section 6.
ALL SHIPS	Urgency, Safety, Routine or Distress priority (see Section 5-3-1)
INDIVIDUAL	Urgency, Safety, Routine or Distress priority (see Section 5-3-2)
GROUP	Routine priority only (see Section 5-3-3)
GEOGRAPHIC	Routine priority only (see Section 5-3-4)
POLLED POSITION	Routine or Safety priority (see Section 5-3-5)
DSC TEST CALL	DSC Test Call (see Section 5-2-11)

In addition to the audible alert, the telephone icon will flash on the screen.

5-3-1 Receiving an All Ships Call (ALL SHIPS)

1. When you receive notification of an ALL SHIP call, press SILENCE (+ or - CH SELECT) to silence the alarm. The priority level and the user MMSI are displayed on the screen. If the radio recognises the user MMSI as one of your buddies, the buddy's name is displayed in place of the user MMSI.
2. Press ACCEPT (ENT) to switch to the designated channel immediately or press QUIT (ESC) to return to the current working channel.

Note: The radio will automatically switch to the designated channel after 10 seconds if no key is pressed and AUTO SWITCH = ON (see Section 4-8):



Note: These additional information screens are available by pressing the + and - keys.



However, if AUTO SWITCH = OFF, then AUTO SW OFF will be displayed and manual channel change is required:



Note: These additional information screens are available by pressing the + and - keys.



3. No acknowledgement is needed. Press PTT to initiate voice contact.
4. The call data is stored in the Call Log (see Section 5-2-7).

5-3-2 Receiving an Individual Call (INDIV)

1. When you receive notification of an INDIV call, press SILENCE (+ or - CH SELECT) to silence the alarm. INDIV calls are almost always Routine priority. If the radio recognises the user MMSI as one of your buddies, the buddy's name is displayed in place of the user MMSI.

```
INDIVIDUAL
SAFETY FROM
TOM
▼ 00:12
```

```
SAFETY FROM
TOM
AUTO SW OFF
▲▼ 00:15
```

```
TOM
AUTO SW OFF
CH67 REQUEST
▲▼ 00:18
```

Note: These additional information screens are available by pressing the + and - keys.

```
AUTO SW OFF
CH67 REQUEST
10:12 UTC
▲▼ 00:20
```

```
CH67 REQUEST
10:12 UTC
ENT-> OPTION
▲▼ 00:23
```

```
10:12 UTC
ENT-> OPTION
KEY->SILENCE
▲▼ 00:25
```

2. Press OPT (ENT) for options on how you want to respond to the call.
Options are:

ACK respond to the call with requested channel

CHANGE CHAN respond to the call with but request a different channel

UNABLE ACK* respond to the call with unable to use the requested channel
(* Note: this option is not available with ROUTINE calls)

3. Or press QUIT (ESC) to return to standby.
4. The call data is stored in the Call Log (see Section 5-2-7).

5-3-3 Receiving a Group Call (GROUP)

1. When you receive notification of a GROUP call, press SILENCE (+ or - CH SELECT) to silence the alarm. The priority level is always routine and the group is identified on the screen. The group will be one of the three groups of frequently called people that you set up earlier (see Section 4-3).
2. Press ACCEPT (ENT) to switch to the designated channel immediately or press QUIT (ESC) to return to the current working channel.

Note: The radio will automatically switch to the designated channel after 10 seconds if no key is pressed and AUTO SWITCH = ON (see Section 4-8):

```
GP 012345678
CALL FROM
TOM
▼ 00:01
```

```
CALL FROM
TOM
AUTO SWITCH
▲▼ 00:02
```

```
TOM
AUTO SWITCH
CH13 IN 10S
▲▼ 00:03
```

Note: These additional information screens are available by pressing the + and - keys.

```
AUTO SWITCH
CH13 IN 10S
10:12 UTC
▲▼ 00:04
```

```
CH13 IN 10S
10:12 UTC
ENT-> ACCEPT
▲▼ 00:05
```

```
10:12 UTC
ENT-> ACCEPT
KEY->SILENCE
▲▼ 00:06
```

However, if AUTO SWITCH =OFF, then AUTO SW OFF will be displayed and manual channel change is required:

```
GP 012345678
CALL FROM
TOM
▼ 00:12
```

```
CALL FROM
TOM
AUTO SW OFF
▲▼ 00:22
```

```
TOM
AUTO SW OFF
CH13 REQUEST
▲▼ 00:25
```

Note: These additional information screens are available by pressing the + and - keys.

```
AUTO SW OFF
CH13 REQUEST
10:12 UTC
▲▼ 00:28
```

```
CH13 REQUEST
10:12 UTC
ENT-> ACCEPT
▲▼ 00:32
```

```
10:12 UTC
ENT-> ACCEPT
KEY->SILENCE
▲▼ 00:35
```

3. The call data is stored in the Call Log (see Section 5-2-7).

5-3-4 Receiving a Geographic Call (GEOGRAPH)

A geographic call is received by vessels within a specific geographic boundary area.

1. When you receive notification of an GEOGRAPH call, press SILENCE (+ or - CH SELECT) to silence the alarm. If the radio recognises the user MMSI as one of your buddies, the buddy's name is displayed in place of the user MMSI.
2. Press ACCEPT (ENT) to switch to the designated channel immediately or press QUIT (ESC) to return to the current working channel.

```
GEOGRAPHICAL
CALL FROM
TOM
▼ 00:12
```

```
CALL FROM
TOM
CH13 REQUEST
▲▼ 00:22
```

```
TOM
CH13 REQUEST
10:11 UTC
▲▼ 00:25
```

Note: These additional information screens are available by pressing the + and - keys.

```
CH13 REQUEST
10:11 UTC
ENT-> ACCEPT
▲▼ 00:28
```

```
10:11 UTC
ENT-> ACCEPT
KEY->SILENCE
▲▼ 00:32
```

3. Monitor the working channel for an announcement from the calling vessel.

5-3-5 Receiving a Polled Position Call (POSITION)

When you receive GPS position data from a buddy in response to your LL request (see Section 5-2-10), you are recommended to make a written note of the position, especially if it is a good fishing position. If enhanced LL position information is available from your buddy, this is shown on the screen until the screen display changes.

```
POSITION
REPLY FROM
TOM
▼ 00:12
```

```
REPLY FROM
TOM
12°23.456'N
▲▼ 00:22
```

```
TOM
12°23.456'N
123°23.789'E
▲▼ 00:25
```

```
12°23.456'N
123°23.789'E
KEY->SILENCE
▲▼ 00:28
```

Section 6 - Distress Calls



WARNING

A valid USER MMSI must be entered into this radio before these DSC functions can be used. See section 4-2 Enter Your USER MMSI (USER MMSI).

6-1 Sending a Distress Call

1. Open the red cover labelled DISTRESS to expose the red Distress key.
2. **TO SEND AN IMMEDIATE DISTRESS CALL** (Undesignated):
HOLD DOWN the DISTRESS key for about 3 seconds, until you see the distress call sending message (DISTRESS CALL SENDING) on the screen.
The whole display starts to flash and beep loudly.

```
DISTRESS CALL
▶UNDEFINED
FIRE
FLOODING ▼
```

```
DISTRESS CALL
>UNDEFINED
HOLD DISTRES
2 SECONDS..
```

```
DISTRESS CALL
SENDING...
```

Or, if time is available, specify the nature of the distress

3. TO SEND A DISTRESS CALL with Distress type:
4. Press and release the DISTRESS key to display the following categories. Use the + or - keys to scroll to the category that describes your situation:

UNDESIGNATED	(Undesignated)
FIRE	(Fire)
FLOODING	(Flooding)
COLLISION	(Collision)
GROUNDING	(Grounding)
LISTING	(Listing)
SINKING	(Sinking)
ADRIFT	(Adrift)
ABANDONING	(Abandoning)
PIRACY	(Piracy)
OVER BOARD	(Over Board)

5. Hold down the DISTRESS key for about 3 seconds, until you see the distress call sending message (DISTRESS CALL SENDING) on the screen. The whole display starts to flash and beep loudly.

6. After the Distress Call is sent, the radio waits for an acknowledgment.
7. The Distress Call is automatically re-sent every 3.5 to 4.5 minutes until a distress acknowledgement is received or:
 - Press **RESEND** (CALL) to immediately resend the Distress Call
 - Press **PAUSE** (3CH) to pause the automatic Distress Call resend timer
 - Press **DISTR.CANCEL** (SCAN) to cancel the Distress Call
 - Press **INFO** (WX) to view details of the sent Distress Call
 - Press **OPT** (ENT) to view and select the available options:

```
DISTRES CALL
SENT! WAIT..
ENT-> OPTION
RESEND:03:30
```

```
OPTION
▶RESEND
  PAUSE ▼
RESEND:03:20
```

```
OPTION
  PAUSE ▲
▶CANCEL
RESEND:03:10
```

Options are:

RESEND to resend the Distress call immediately.

PAUSE to PAUSE the RESEND countdown timer. Press ESC to continue.

CANCEL to CANCEL the Distress Call and transmit a DISTRESS CANCEL call. Use the PTT microphone to report your situation:

```
OPTION
  PAUSE ▲
▶CANCEL
RESEND:03:20
```

```
SEND CANCEL?
▶YES
  NO
RESEND:03:20
```

```
DISTR CANCEL
SENDING..
```

```
DISTR CANCEL
SENT
PTT-->REASON
```

```
DISTR CANCEL
COMPLETED
ESC-> EXIT
```

8. After a DISTRESS ACK is received, press SILENCE (+ or - CH SELECT) to silence the alarm, then use the PTT microphone to report your situation.
9. The following information (if available) is contained in the Distress Call:
 - Nature Of Distress (if available)
 - Position information. The latest GPS or manual input position is held for 23.5 hours, or until the power is turned OFF.

6-2 Receiving a Distress Call (DISTRESS!)

1. An alert sounds when a distress call (DISTRESS!) is received. Press SILENCE (+ or - CH SELECT) to silence the alarm. You do not need to send an acknowledgement.

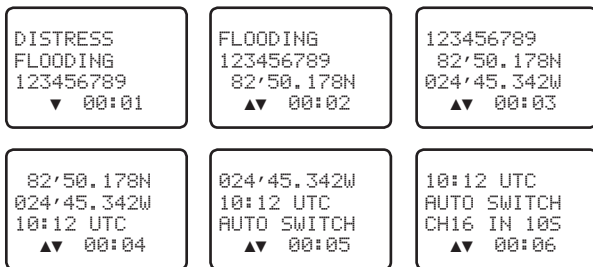

Note: These additional information screens are available by pressing the + and - keys.

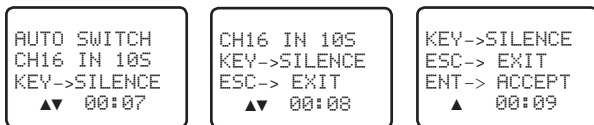

2. The radio will automatically select CH16 after 10 seconds if no user intervention, or press ACCEPT (ENT) to change to CH16 immediately.

Details of the distress call are shown on the screen. Details include the user MMSI and nature of the emergency (if specified), also the time and the location (if specified). If the location and time are not specified, these are replaced with sequences of 9s and 8s respectively.

3. Press PTT to establish voice contact.

This radio is capable of receiving enhanced LL position data if the radio transmitting the Distress Call is sending this. This provides the position of the distressed vessel to within 20 m (60ft).

6-3 Distress Acknowledgement (DISTRESS ACK)

An alert sounds when a Distress Relay (DISTRESS RELAY) is received. Press SILENCE (+ or - CH SELECT) to silence the alarm.

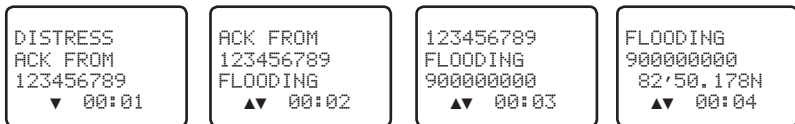

Try to make voice contact with the calling vessel. Maintain a listening watch on CH16 and standby to lend assistance

For a Distress Acknowledgement (DISTRESS ACK) sent from the Search and Rescue (SAR) authorities of your country, your radio automatically cancels Distress Mode transmissions and CH16 appears. Press PTT to establish voice contact with the Search and Rescue (SAR) authority.

The Search and Rescue (SAR) authorities of your country are the only instance allowed to send a Distress Acknowledgement (DISTRESS ACK).

6-4 Distress Relay Individual (INDIV DISTR RELAY)

When an incoming Individual Distress Relay call is received, the alarm sounds and INDIV DISTR RELAY is displayed.

1. Press SILENCE (+ or - CH SELECT) to silence the alarm.
2. Press + or - button to scroll any further information about the call
3. **ALL MODELS:** Press ACCEPT (ENT) key to immediately accept the channel change before the 10s timer expires
4. **US MODELS:** Press ACK (ENT) key to ACK the call after the 10s delay (when INDIV REPLY is set to MANUAL)
5. Or press QUIT (ESC) to return to standby.

The call data is stored in the Call Log (see Section 5-2-7).

Individual Distress Relay functionality will vary depending on your radio model:

ALL models: Prior to 10s Auto Channel change timer expires, display shows:

```
INDIV DISTR
RELAY FROM
900000000
▼ 00:00
```

```
FLOODING
123000000
55°29.975'N
▲▼ 00:03
```

```
CH16 IN 10S
KEY->SILENCE
ESC-> EXIT
▲▼ 00:06
```

```
KEY->SILENCE
ESC-> EXIT
ENT-> ACCEPT
▲ 00:07
```

EU only models: ACCEPT (ENT) key is pressed, or 10s Auto Channel change timer expires:

```
INDIV DISTR
RELAY FROM
900000000
▼ 00:00
```

```
FLOODING
123000000
55°29.975'N
▲▼ 00:03
```

```
012°18.559'E
02:43UTC
CHANNEL IS
▲▼ 00:06
```

```
AUTO CHANGED
KEY->SILENCE
ESC-> EXIT
▲ 00:07
```

US only models: ACT (ENT) key is pressed, or MANUAL / AUTO ACK (depending on INDIV REPLY setting):

```
INDIV DISTR
RELAY FROM
900000000
▼ 00:00
```

```
FLOODING
123000000
55°29.975'N
▲▼ 00:03
```

```
AUTO CHANGED
KEY->SILENCE
ENT-> ACK
▲ 00:06
```

```
KEY->SILENCE
ENT-> ACK
ESC-> EXIT
▲ 00:07
```

Section 7 - Installation

This Simrad radio is designed to generate a digital maritime distress call to facilitate search and rescue. To be effective as a safety device, this radio must be used only within the geographic range of a shore-based VHF marine Channel 70 distress and safety watch system. The geographic range may vary but under normal conditions is approximately 20 nautical miles.

Installation Options

There are two ways to install the radio. You can choose:

- *A deck or overhead mounted gimbal installation.* The reversible mounting gimbal is fixed to a suitable site and the radio is placed into it. The radio can be removed for storage and the viewing angle can be adjusted.
- *A recessed installation.* The radio is recessed into a cavity cut into a bulkhead. The radio fixture is permanent and the viewing angle cannot be adjusted.

Location Requirements

Please check these **before** doing any cutting or drilling.

Whichever installation method you choose, ensure that the chosen location:

- Is at least 3' (1 m) from the antenna
- Allows easy connection to (at least) a 10 Amp fused 13.6 V DC electrical source and the antenna
- Is at least 1.5' (45 cms) from the compass to avoid creating magnetic deviation of the compass during radio operation
- Has a suitable space close by for installing the microphone bulkhead mount
- Provides easy access to the controls on the front panel
- Provides reasonable access to the wiring at the back of the radio
- Provides enough room to fix the DSC warning label

The VHF has a large LCD screen with an optimum viewing angle of approx. +/-20 deg. Ensure the chosen location provides a suitable view of the display. Ideally, the user should be directly in front of the display or no more than +/-20 deg from the front of the display.

Note: If unsure, temporarily power up the radio and check for a suitable location.

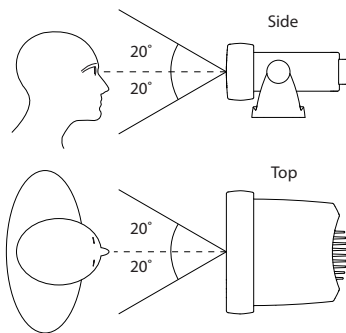

Checklist

The following items should be supplied in the box. Check before starting the installation and contact your dealer if an item is missing.

Note: An antenna is **not** provided. Consult your Simrad dealer for advice if necessary.

1. Mounting gimbal for the VHF radio
2. Power supply cable with in-built 7 Amp fuse
3. External speaker connection cable with white (+) wire and black (-) wire
4. GPS connection cable
5. Two mounting knobs
6. Microphone bulkhead mount
7. Four countersunk self-tapping screws for the mounting gimbal
8. Four flat screws for the mounting gimbal
9. Four spring washers for the mounting gimbal
10. Four plain washers for the mounting gimbal

11. Four nuts for the mounting gimbal
12. Two self-tapping screws for the microphone bulkhead mount
13. Two flat screws for the microphone bulkhead mount
14. Two spring washers for the microphone bulkhead mount
15. Two plain washers for the microphone bulkhead mount
16. Two nuts for the microphone bulkhead mount
17. Two adapter plates for recessed installation
18. Screw kit for recessed installation

Not pictured:

- Installation template and Warranty card
- DSC Warning label sticker
- This Operation and Installation manual
- One 7 Amp spare fuse in case of accidental reverse of battery polarity
- Base unit and microphone

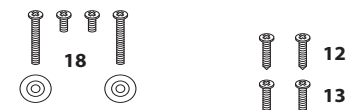
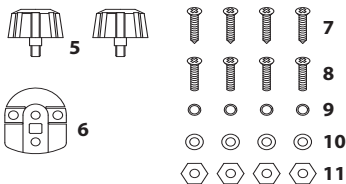
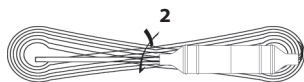
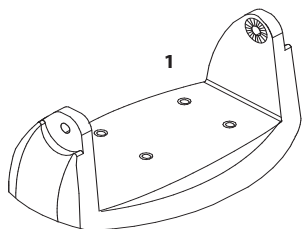

Gimbal Installation

1. Hold the mounting gimbal at the chosen location and use a soft pencil to mark the screw hole positions onto the mounting surface.
2. If you can't reach behind the mounting surface to attach the nuts, use the self-tapping screws instead of the flat screws shown in the picture. If you're drilling into fiberglass, use a drill bit smaller than 3/16" (5mm) to drill the pilot holes.

Otherwise, drill the four screw holes where marked, using a 3/16" (5 mm) drill bit. Drill completely through the mounting surface.
3. Use a Philips screwdriver and the set of four flat screws, spring washers, plain washers, and nuts to attach the mounting gimbal to the location site.
4. Slide the radio into the mounting gimbal.
5. Insert the two mounting knobs through the holes and tighten them sufficiently to hold the radio at the desired viewing angle.

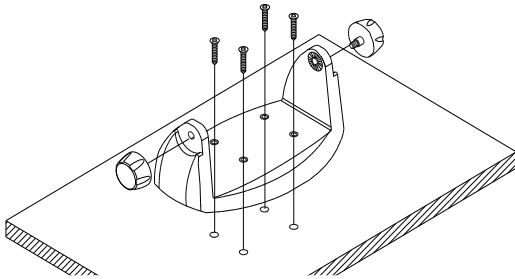

Change the Viewing Angle

The viewing angle on the gimbal mount has a 20° tilt range. To change the current viewing angle on the gimbal mount:

1. Support the radio, then cautiously loosen the mounting knobs until the radio can be moved.
2. Re-position the radio then tighten the mounting knobs again.

Recessed Installation

1. Tape the installation template onto the chosen location site.
2. Cut out the area marked by the solid dark line (the dashed line indicates the total area that will be covered by the radio fascia after installation).
3. Remove the installation template and slide the radio into the cavity.
4. Working from the rear of the bulkhead, align the ratched outstand on each side of the

radio with the central hole in each mounting bracket.

5. Use the two short M5x10 screws to screw the mounting brackets to the sides of the radio.
6. Slide each M5x32 screw through the screw hole in the mounting bracket, then attach the lock nut and the stopper. If your bulkhead exceeds 13 mm, the stopper nut can be discarded if necessary.
7. Tighten the M5x32 screws until the radio is held against the rear of the bulkhead.
8. Tighten up the lock nuts to secure the installation.

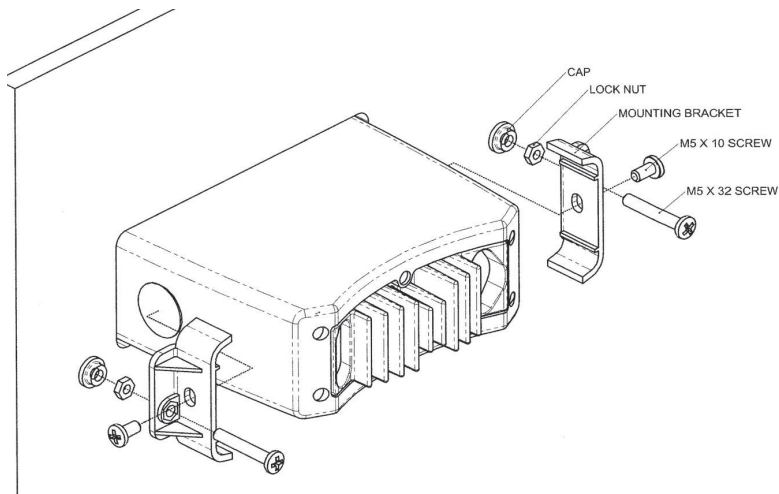

Install the Microphone Bulkhead Mount

1. Hold the microphone bulkhead mount at the chosen location and use a soft pencil to mark the screw hole positions on the mounting surface. *Ensure that the microphone curly cable will comfortably reach this location BEFORE you drill.*
2. Drill the two pilot screw holes where marked.
3. Use a short length Philips screwdriver and the set of two flat screws, spring washers, plain washers, and nuts to secure the microphone bulkhead mount at the location site.
4. Hang the microphone on its mount.

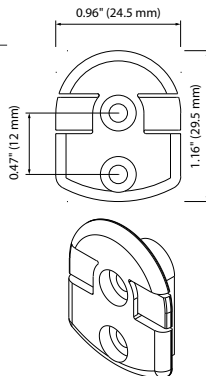

Fix the DSC label

CAUTION

A DSC warning label is supplied with US versions of this radio. To comply with FCC regulations, this warning label must be affixed in a location that is clearly visible from the operating controls of this radio. Make sure that the chosen location is clean and dry before applying this label.

Connect the Radio Cables

The connectors are on the rear of the base unit, as follows:

- 1 GPS/COM connector.** For connection to GPS device via NMEA (If you are not using this, be sure to put the protective cap securely over the connector to protect it from moisture and dust).
- 2 GPS/COM cable.** For above connector. See the following table for wiring and color codes.
- 3 Red Power wire.** Connect this to the Positive (+) battery terminal. Check that a 7 Amp fuse is installed on this power cable close to the battery.
- 4 Black Power wire.** Connect this to the Negative (-) battery terminal.
- 5 External Speaker connector.** Connect to an external speaker BEFORE powering on the radio. Use a 4 Ohm 6 Watt external speaker. White wire to speaker (+). Bare wire to speaker (-). NOTE: Ensure wires are electrically insulated if not used.
- 6 ANT.** A radio antenna is not supplied. A suitable radio antenna must be mounted and connected before operating this radio. Consult your dealer for advice if necessary.
- 7 GND.** A ground connection is not usually required.
- 8 NMEA 2000 connector.** For connection to a compatible NMEA 2000 network.

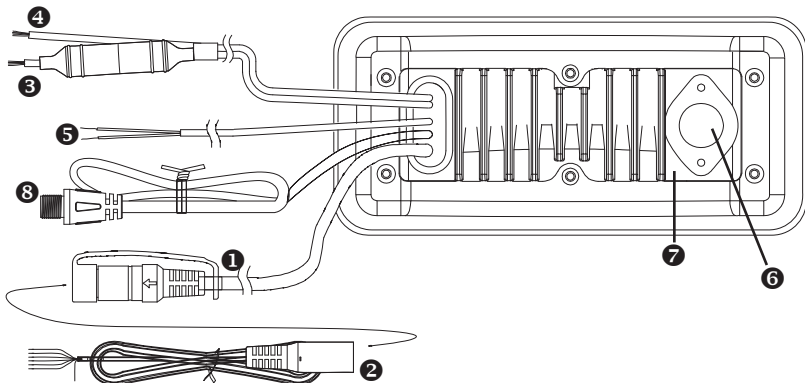

Wiring for GPS/COM connector

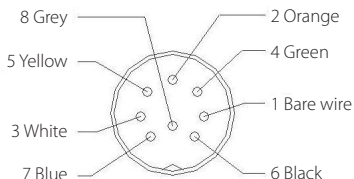
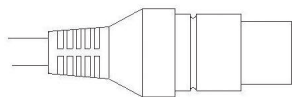

Pin	Wire	Function	Notes
1	Red	No connection	(Not used)
2	Orange	NMEA OUT (+)	(To GPS)
3	White	Program/clone	(Not used)
4	Green	NMEA IN (-)	(From GPS)
5	Yellow	NMEA IN (+)	(From GPS)
6	Black	NMEA OUT (-)	(Ground)
7	Blue	No connection	(Not used)
8	Grey	No connection	(Not used)

Wiring for NMEA 2000 connector

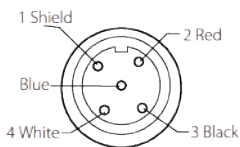

Pin	Wire	Function
1	Green	Can-D, Drain wire, Shield
2	Red	Can-S, Power, +12 V DC
3	Black	Can-C, Ground
4	White	Can-H, Data HIGH
5	Blue	Can-L, Data LOW

Set Up the Radio

CAUTION

You can not make any DSC transmissions until you have obtained a user MMSI and entered it into your radio.

You must obtain a user MMSI (Marine Mobile Service Identity) and enter it into your radio before you can use the DSC functions.

The user MMSI is a unique nine digit number, similar to a personal telephone number. It is used on marine transceivers that are capable of using DSC (Digital Select Calling).

If you don't have a user MMSI contact the appropriate authorities in your country. If you are unsure who to contact, consult your Simrad dealer.

- A Group MMSI begins with 0 followed by 8 numeric digits (0xxxxxxx)
- A Coast Station MMSI begins with 00 followed by 7 numeric digits. You just need to add the 7 digits and the radio will add the beginning 00 for you
- See section 4-2 Enter Your USER MMSI (USER MMSI).

To enable the DSC functions in this radio:

- Enter your valid MMSI: MENU > DSC SETUP > USER MMSI
- Ensure DSC is turned ON: MENU > DSC SETUP > DSC FUNC

Depending upon your location, you may need a radio station license for this radio. You may also need an individual operator's license.

Simrad recommends that you check the requirements of your national radio communications authorities before operating this radio and the DSC functions.

The Completed Installation

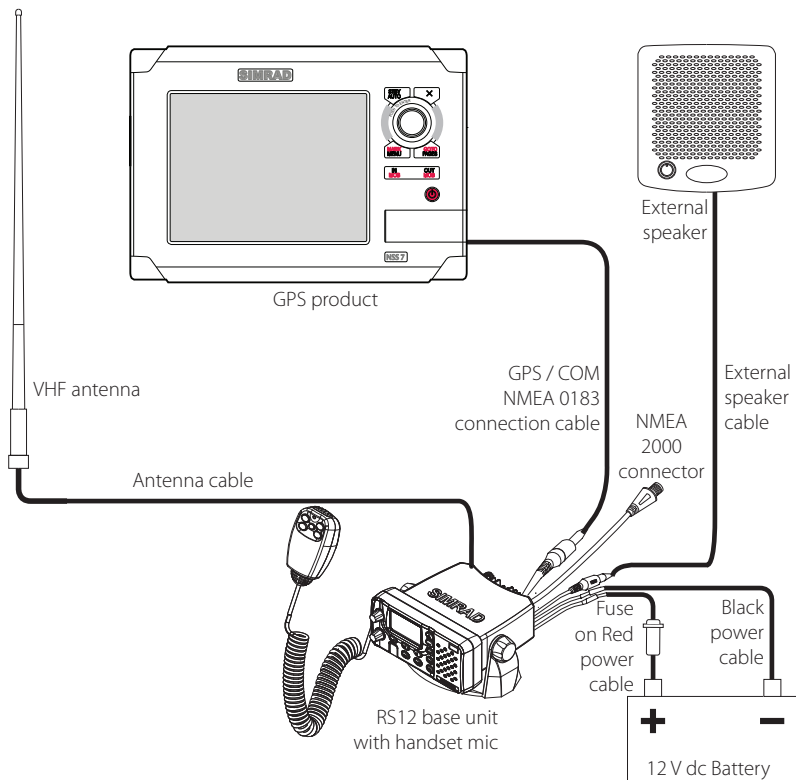

⚠ CAUTION

Under extreme operating conditions, the temperature of the rear heat-sink on this radio may exceed normal surface temperatures. Caution is advised to prevent possible skin burns.

Appendix A - Technical Specifications

SIMRAD RS12

GENERAL

Power supply:	12 V DC battery system
Low battery alert:	10.6 V DC +/- 5%
Current drain - Transmit	5 A at 25 W Tx / 1.5 A at 1 W Tx (@ 12 V DC)
Receive	Less than 250 mA in standby
Temperature range:	-20°C to +55°C (-4°F to 131°F)
Usable channels:	International, USA, Canada, Weather (country specific)
Mode:	16K0G3E (FM) / 16K0G2B (DSC)
DSC mode:	Class D (Global) with dual receiver (individual CH70)
Standards:	ITU-R M.493-13 (US models), EN 300-338-3 (EU models)

PHYSICAL

LCD display (viewing):	46 x 26 mm (1.8 x 1.0"), matrix FSTN
Contrast control:	Yes
Dimming control:	Yes
Antenna connector:	SO-239 (50 ohm)
Waterproof:	JIS-7
Dimensions:	161(W) x 75(H) x 147(D) mm - without bracket
Weight:	1.29 kg (2.8 lbs) - without microphone
Compass safe distance:	0.5 m (1.5')
Frequency stability:	+/- 10 ppm
Frequency control:	PLL
Comm. port - NMEA 0183:	NMEA 0183, 4800 baud
Comm. port - NMEA 2000:	NMEA 2000
DSC:	Yes, CLASS-D (Global - separate CH70 receiver built in)
GPS/NMEA input:	Yes; RMC, GGA, GLL, GNS
NMEA output:	Yes; DSC (for DSC call), DSE (for enhanced position).

FEATURES

Flush mount kit	Yes
Dust Cover	Yes
Local/Distant control:	Yes
Position polling:	Yes
Group call:	Yes
Call logs:	Yes - 20 individual and 10 distress
Channel naming:	Yes
Tri watch:	Yes
Favourite channel scan:	Yes
All scan:	Yes
User programmable MMSI:	Yes
MMSI and NAME directory:	Yes - 20 numbers & group

TRANSMITTER

Frequency:	156.025 - 157.425 MHz
Output power:	25 W / 1 W selectable
Transmitter protection:	Open / short circuit of antenna
Max Frequency deviation:	+/- 5 kHz
Spurious & harmonics:	better than 0.25 μ W
Modulation distortion:	Less than 4% @ 1kHz for a +/-3 kHz deviation

RECEIVER

Frequency:	156.025 - 163.275 MHz
12dB SINAD sensitivity:	0.25 μ V (distant) / 0.8 μ V (local)
20db SINAD sensitivity:	0.35 μ V
Adjacent CH selectivity:	more than 70 db
Spurious response:	more than 70 db
Intermodulation rejection ratio:	more than 68 db
Residual noise level:	more than -40 db unscelched
Audio output power:	2 W (with 8 ohm at 10% distortion) 4 W with 4 ohm external speaker

Note: Specifications are subject to change without notice.

Appendix B - Troubleshooting

1. The transceiver will not power up.

A fuse may have blown OR there is no voltage getting to the transceiver.

- a. Check the power cable for cuts, breaks, or squashed sections.
- b. After checking the wiring, replace the 7 Amp fuse (1 spare fuse is supplied).
- c. Check the battery voltage. This must be greater than 10.5 V.

2. The transceiver blows the fuse when the power is switched on.

The power wires may have been reversed.

- a. Check that the red wire is connected to the positive battery terminal, and the black wire is connected to the negative battery terminal.

3. The speaker makes popping or whining noises when the engine is running.

Electrical noise may be interfering with the transceiver.

- a. Re-route the power cables away from the engine.
- b. Add a noise suppressor to the power cable.
- c. Use resistive spark plug wires and/or use an alternator whine filter.

4. No sound from the external speaker.

- a. Check that the external speaker cable is physically connected.
- b. Check the soldering of the external speaker cable.

5. Transmissions are always on low power, even when high (HI) power is selected.

The antenna may be faulty.

- a. Test the transceiver with a different antenna.
- b. Have the antenna checked out.

6. Battery symbol is displayed.

The power supply is too low or too high.

- a. Check the battery voltage. This should be at least $10.5\text{ V} \pm 0.5\text{ V DC}$.
- b. Check the alternator on the vessel.

7. No position information is displayed.

The GPS cable may be faulty or the GPS setting may be incorrect.

- a. Check that the GPS cable is physically connected.
- b. Check the polarity of the GPS cable.
- c. Check the baud rate setting of the GPS if applicable. The baud rate setting should be 4800 and parity should be set to NONE.

Appendix C - US & ROW VHF Marine Channel Charts

The following channel charts are provided for reference only and may not be correct for all regions. It is the operators responsibility to ensure correct channels and frequencies are used for local regulations.

C-1 International Channel Chart

CH	TX (MHz)	RX (MHz)	MODE	TRAFFIC TYPE	SHIP TO SHIP	SHIP TO SHORE	NAME TAG	REMARK
01	156.050	160.650	D	Public Correspondence	No	Yes	TELEPHONE	
02	156.100	160.700	D	Public Correspondence	No	Yes	TELEPHONE	
03	156.150	160.750	D	Public Correspondence	No	Yes	TELEPHONE	
04	156.200	160.800	D	Port Operations	No	Yes	PORT OPS	
05	156.250	160.850	D	Port Operations	No	Yes	PORT OPS/VTS	
06	156.300	156.300	S	Inter-ship Safety	Yes	No	SAFETY	
07	156.350	160.950	D	Port Operations	No	Yes	PORT OPS	
08	156.400	156.400	S	Commercial (inter-ship only)	Yes	No	COMMERCIAL	
09	156.450	156.450	S	Inter-ship	Yes	Yes	CALLING	
10	156.500	156.500	S	Commercial	Yes	Yes	COMMERCIAL	
11	156.550	156.550	S	Port Operations	Yes	Yes	VTS	
12	156.600	156.600	S	Port Operations	Yes	Yes	PORT OPS/VTS	
13	156.650	156.650	S	Inter-ship Navigation Safety (bridge-to-bridge)	Yes	No	BRIDGE COM	
14	156.700	156.700	S	Port Operations	Yes	Yes	PORT OPS/VTS	
15	156.750	156.750	S	Port Operations	Yes	Yes	PORT OPS	⊙ 1W only
16	156.800	156.800	S	International Distress, Safety, and Calling	Yes	Yes	DISTRESS	
17	156.850	156.850	S	State Controlled	Yes	Yes	SAR	⊙ 1W only
18	156.900	161.500	D	Port Operations	No	Yes	PORT OPS	
19	156.950	161.550	D	Ship to Shore	No	Yes	SHIP-SHORE	
20	157.000	161.600	D	Port Operations	No	Yes	PORT OPS	
21	157.050	161.650	D	Port Operations	No	Yes	PORT OPS	
22	157.100	161.700	D	Port Operations	No	Yes	PORT OPS	
23	157.150	161.750	D	Public Correspondence	No	Yes	TELEPHONE	
24	157.200	161.800	D	Public Correspondence	No	Yes	TELEPHONE	
25	157.250	161.850	D	Public Correspondence	No	Yes	TELEPHONE	
26	157.300	161.900	D	Public Correspondence	No	Yes	TELEPHONE	
27	157.350	161.950	D	Public Correspondence	No	Yes	TELEPHONE	
28	157.400	162.000	D	Public Correspondence	No	Yes	TELEPHONE	
60	156.025	160.625	D	Public Correspondence	No	Yes	TELEPHONE	
61	156.075	160.675	D	Port Operations	No	Yes	PORT OPS	

62	156.125	160.725	D	Port Operations	No	Yes	PORT OPS	
63	156.175	160.775	D	Port Operations	No	Yes	PORT OPS	
64	156.225	160.825	D	Public Correspondence	No	Yes	TELEPHONE	
65	156.275	160.875	D	Port Operations	No	Yes	PORT OPS	
66	156.325	160.925	D	Port Operations	No	Yes	PORT OPS	
67	156.375	156.375	S	Commercial, bridge-to-bridge	Yes	No	BRIDGE COM	
68	156.425	156.425	S	Inter-ship	Yes	No	SHIP-SHIP	
69	156.475	156.475	S	Port Operations	Yes	Yes	PORT OPS	
70	156.525	156.525	-	Digital Selective Calling - DSC	-----	-----	DSC	②
71	156.575	156.575	S	Port Operations	Yes	Yes	PORT OPS	
72	156.625	156.625	S	Inter-ship	Yes	No	SHIP-SHIP	
73	156.675	156.675	S	Port Operations	Yes	Yes	PORT OPS	
74	156.725	156.725	S	Port Operations	Yes	Yes	PORT OPS	
77	156.875	156.875	S	Ship to Shore	Yes	No	SHIP-SHORE	
78	156.925	161.525	D	Ship to Shore	No	Yes	SHIP-SHORE	
79	156.975	161.575	D	Port Operations	No	Yes	PORT OPS	
80	157.025	161.625	D	Port Operations	No	Yes	PORT OPS	
81	157.075	161.675	D	Public Correspondence	No	Yes	TELEPHONE	
82	157.125	161.725	D	Public Correspondence	No	Yes	TELEPHONE	
83	157.175	161.775	D	Public Correspondence	No	Yes	TELEPHONE	
84	157.225	161.825	D	Public Correspondence	No	Yes	TELEPHONE	
85	157.275	161.875	D	Public Correspondence	No	Yes	TELEPHONE	
86	157.325	161.925	D	Public Correspondence	No	Yes	TELEPHONE	
87	157.375	161.975	D	Public Correspondence	No	Yes	TELEPHONE	
88	157.425	162.025	D	Public Correspondence	No	Yes	TELEPHONE	

Special Notes on International Channel Usage

- ①. LOW POWER (1W) only.
- ②. Channel 70 is designated for use exclusively for Digital Selective Calling (DSC), such as Distress, Safety, and Ship Calls. No voice communication is allowed on CH70. This channel is only available on DSC enabled radios.

Note:

- The INTERNATIONAL channel bank is not legal for use in U.S. or Canada waters.
- Select the INTERNATIONAL channel bank for use in Australia, New Zealand and other Asia Pacific regions, and all other regions where otherwise not specified.

KEY: S = Simplex operating channel; D = Duplex operating channel.

C-2 USA Channel Chart

CH	TX (MHz)	RX (MHz)	MODE	TRAFFIC TYPE	SHIP TO SHIP	SHIP TO SHORE	NAME TAG	REMARK
01A	156.050	156.050	S	Port Operations, Selected VTS Areas	Yes	Yes	PORT OPS/VTS	
03A	156.150	156.150	S	US Government, Coast Guard	Yes	Yes	UNAUTHORIZED	④
05A	156.250	156.250	S	Port Operations, Selected VTS Areas	Yes	Yes	PORT OPS/VTS	
06	156.300	156.300	S	Inter-ship Safety	Yes	No	SAFETY	
07A	156.350	156.350	S	Commercial	Yes	Yes	COMMERCIAL	
08	156.400	156.400	S	Commercial (inter-ship only)	Yes	No	COMMERCIAL	
09	156.450	156.450	S	Recreational Calling Channel	Yes	Yes	CALLING	
10	156.500	156.500	S	Commercial	Yes	Yes	COMMERCIAL	
11	156.550	156.550	S	Commercial, VTS in Selected Areas	Yes	Yes	VTS	
12	156.600	156.600	S	Port Operations, Selected VTS Areas	Yes	Yes	PORT OPS/VTS	
13	156.650	156.650	S	Inter-ship Navigation Safety (bridge-to-bridge), 1W with Power-up	Yes	No	BRIDGE COM	③ 1W
14	156.700	156.700	S	Port Operations, Selected VTS Areas	Yes	Yes	PORT OPS/VTS	
15	---	156.750	S	Environmental	-----	-----	ENVIRONMENTAL	② RX only
16	156.800	156.800	S	International Distress, Safety, and Calling	Yes	Yes	DISTRESS	
17	156.850	156.850	S	State Controlled	Yes	Yes	SAR	① 1W only
18A	156.900	156.900	S	Commercial	Yes	Yes	COMMERCIAL	
19A	156.950	156.950	S	Commercial	Yes	Yes	COMMERCIAL	
20	157.000	161.600	D	Port Operations, Canadian Coast Guard	No	Yes	PORT OPS	
20A	157.000	157.000	S	Port Operations	Yes	Yes	PORT OPS	
21A	157.050	157.050	S	U.S. Government, Canadian Coast Guard	Yes	Yes	UNAUTHORIZED	④
22A	157.100	157.100	S	Coast Guard Liaison	Yes	Yes	COAST GUARD	
23A	157.150	157.150	S	U.S. Government, Coast Guard	Yes	Yes	UNAUTHORIZED	④
24	157.200	161.800	D	Public Correspondence, Marine operator	No	Yes	TELEPHONE	
25	157.250	161.850	D	Public Correspondence, Marine operator	No	Yes	TELEPHONE	
26	157.300	161.900	D	Public Correspondence, Marine operator	No	Yes	TELEPHONE	
27	157.350	161.950	D	Public Correspondence, Marine operator	No	Yes	TELEPHONE	
28	157.400	162.000	D	Public Correspondence, Marine operator	No	Yes	TELEPHONE	
61A	156.075	156.075	S	U.S. Government, Canadian Coast Guard	Yes	Yes	UNAUTHORIZED	④
63A	156.175	156.175	S	Port Operations, VTS in Selected Areas	Yes	Yes	PORT OPS/VTS	
64A	156.225	156.225	S	U.S. Government, Canadian Commercial Fishing	Yes	Yes	UNAUTHORIZED	④
65A	156.275	156.275	S	Port Operations	Yes	Yes	PORT OPS	
66A	156.325	156.325	S	Port Operations	Yes	Yes	PORT OPS	
67	156.375	156.375	S	Commercial, bridge-to-bridge, 1W with Power-up	Yes	No	BRIDGE COM	③ 1W

68	156.425	156.425	S	Boat Operations, Recreational	Yes	No	SHIP - SHIP	
69	156.475	156.475	S	Boat Operations, Recreational	Yes	Yes	PLEASURE	
70	156.525	156.525		Digital Selective Calling - DSC	-----	-----	DSC	Ⓒ
71	156.575	156.575	S	Boat Operations, Recreational	Yes	Yes	PLEASURE	
72	156.625	156.625	S	Boat Operations, Recreational	Yes	No	SHIP - SHIP	
73	156.675	156.675	S	Port Operations	Yes	Yes	PORT OPS	
74	156.725	156.725	S	Port Operations	Yes	Yes	PORT OPS	
77	156.875	156.875	S	Port Operations	Yes	Yes	PORT OPS	① 1W only
78A	156.925	156.925	S	Boat Operations, Recreational	Yes	No	SHIP - SHIP	
79A	156.975	156.975	S	Commercial	Yes	Yes	COMMERCIAL	
80A	157.025	157.025	S	Commercial	Yes	Yes	COMMERCIAL	
81A	157.075	157.075	S	U.S. Government, Environmental Protection Agency Operations	Yes	Yes	UNAUTHORIZED	④
82A	157.125	157.125	S	U.S. Government, Canadian Coast Guard	Yes	Yes	UNAUTHORIZED	④
83A	157.175	157.175	S	U.S. Government, Canadian Coast Guard	Yes	Yes	UNAUTHORIZED	④
84	157.225	161.825	D	Public Correspondence, Marine Operator	No	Yes	TELEPHONE	
84A	157.225	157.225	S	Public Correspondence, Marine Operator				
85	157.275	161.875	D	Public Correspondence, Marine Operator	No	Yes	TELEPHONE	
85A	157.275	157.275	S	Public Correspondence, Marine Operator				
86	157.325	161.925	D	Public Correspondence, Marine Operator	No	Yes	TELEPHONE	
86A	157.325	157.325	S	Public Correspondence, Marine Operator				
87	157.375	161.975	D	Public Correspondence, Marine Operator	No	Yes	TELEPHONE	
87A	157.375	157.375	S	Public Correspondence, Marine Operator				
88	157.425	162.025	D	Public Correspondence, Marine Operator	No	Yes	TELEPHONE	
88A	157.425	157.425	S	Commercial, Inter-ship Only	Yes	No	COMMERCIAL	

Special Notes on USA Channel Usage

- ①. LOW POWER (1 W) only.
- ②. Receive Only.
- ③. LOW POWER (1 W) initially. Override to HIGH POWER by holding down H/L key before transmitting. Used normally in bridge-to-bridge communications.
- ④. Lightly shaded simplex channels 03A, 21A, 23A, 61A, 64A, 81A, 82A, and 83A cannot be lawfully used in U.S. waters unless special authorization is obtained from the U.S. Coast Guard. Not for use by the general public.
- ⑤. The letter "A" illuminated by the channel number indicates the USA channel is simplex. This same channel is always duplex when selecting International. There is no "A" reference for International channels. The letter "B" is only used for some Canadian "Receive only" channels.
- ⑥. Channel 70 is designated for use exclusively for Digital Selective Calling (DSC), such as Distress, Safety, and Ship Calls. No voice communication is allowed on CH70. This channel is only available on DSC enabled radios.

KEY: S = Simplex operating channel; D = Duplex operating channel.

C-3 CANADA Channel Chart

CH	TX (MHz)	RX (MHz)	MODE	TRAFFIC TYPE	SHIP TO SHIP	SHIP TO SHORE	NAME TAG	REMARK
01	156.050	160.650	D	Public Correspondence	No	Yes	TELEPHONE	
02	156.100	160.700	D	Public Correspondence	No	Yes	TELEPHONE	
03	156.150	160.750	D	Public Correspondence	No	Yes	TELEPHONE	
04A	156.200	156.200	S	Canadian Coast Guard, SAR	Yes	Yes	CANADIAN CG	
05A	156.250	156.250	S	Port Operations, VTS in Selected Areas	Yes	Yes	PORT OPS/VTS	
06	156.300	156.300	S	Inter-ship Safety	Yes	No	SAFETY	
07A	156.350	156.350	S	Commercial	Yes	Yes	COMMERCIAL	
08	156.400	156.400	S	Commercial (inter-ship only)	Yes	No	COMMERCIAL	
09	156.450	156.450	S	Recreational Calling Channel	Yes	Yes	CALLING	
10	156.500	156.500	S	Commercial	Yes	Yes	COMMERCIAL	
11	156.550	156.550	S	Commercial, VTS in Selected Areas	Yes	Yes	VTS	
12	156.600	156.600	S	Port Operations, VTS in Selected Areas	Yes	Yes	PORT OPS/VTS	
13	156.650	156.650	S	Inter-ship Navigation Safety (bridge-to-bridge) 1W with power-up	Yes	No	BRIDGE COM	⊙ 1W
14	156.700	156.700	S	Port Operations, VTS in Selected Areas	Yes	Yes	PORT OPS/VTS	
15	156.750	156.750	S	Commercial	Yes	Yes	COMMERCIAL	⊙ 1W only
16	156.800	156.800	S	International Distress, Safety, and Calling	Yes	Yes	DISTRESS	
17	156.850	156.850	S	State Controlled	Yes	Yes	SAR	⊙ 1W only
18A	156.900	156.900	S	Commercial	Yes	Yes	COMMERCIAL	
19A	156.950	156.950	S	Canadian Coast Guard	Yes	Yes	CANADIAN CG	
20	157.000	161.600	D	Canadian Coast Guard	No	Yes	CANADIAN CG	⊙ 1W only
21	157.050	161.650	D	Port Operations	No	Yes	PORT OPS	
21A	157.050	157.050	S	U.S. Government, Canadian Coast Guard	Yes	Yes	UNAUTHORIZED	
21B	---	161.650	S	Port Operations	-----	-----	PORT OPS	RX only
22A	157.100	157.100	S	Canadian Coast Guard Liaison	Yes	Yes	CANADIAN CG	
23	157.150	161.750	D	Public Correspondence	No	Yes	TELEPHONE	
24	157.200	161.800	D	Public Correspondence	No	Yes	TELEPHONE	
25	157.250	161.850	D	Public Correspondence	No	Yes	TELEPHONE	
25B	---	161.850	S	Public Correspondence	-----	-----	TELEPHONE	RX only
26	157.300	161.900	D	Public Correspondence	No	Yes	TELEPHONE	
27	157.350	161.950	D	Public Correspondence	No	Yes	TELEPHONE	
28	157.400	162.000	D	Public Correspondence	No	Yes	TELEPHONE	
28B	---	162.000	S	Public Correspondence	-----	-----	TELEPHONE	RX only
60	156.025	160.625	D	Public Correspondence	No	Yes	TELEPHONE	
61A	156.075	156.075	S	U.S. Government, Canadian Coast Guard	Yes	Yes	UNAUTHORIZED	⊙

62A	156.125	156.125	S	Canadian Coast Guard	Yes	Yes	CANADIAN CG	
64	156.225	160.825	D	Public Correspondence, Duplex	No	Yes	TELEPHONE	
64A	156.225	156.225	S	U.S. Government, Canadian Commercial Fishing	Yes	Yes	UNAUTHORIZED	④
65A	156.275	156.275	S	Port Operations	Yes	Yes	PORT OPS	
66A	156.325	156.325	S	Port Operations	Yes	Yes	PORT OPS	① 1W only
67	156.375	156.375	S	Commercial, SAR	Yes	No	COMMERCIAL	
68	156.425	156.425	S	Boat Operations, Recreational	Yes	No	SHIP - SHIP	
69	156.475	156.475	S	Commercial Fishing Only	Yes	Yes	COMMERCIAL	
70	156.525	156.525	S	Digital Selective Calling - DSC	-----	-----	DSC	⑤
71	156.575	156.575	S	Boat Operations, Recreational	Yes	Yes	PLEASURE	
72	156.625	156.625	S	Inter-ship	Yes	No	SHIP - SHIP	
73	156.675	156.675	S	Commercial Fishing Only	Yes	Yes	COMMERCIAL	
74	156.725	156.725	S	Commercial Fishing Only	Yes	Yes	COMMERCIAL	
77	156.875	156.875	S	Port Operations	Yes	Yes	PORT OPS	① 1W only
78A	156.925	156.925	S	Boat Operations, Recreational	Yes	No	SHIP - SHIP	
79A	156.975	156.975	S	Commercial	Yes	Yes	COMMERCIAL	
80A	157.025	157.025	S	Commercial	Yes	Yes	COMMERCIAL	
81A	157.075	157.075	S	U.S. Government Operations	Yes	Yes	UNAUTHORIZED	④
82A	157.125	157.125	S	U.S. Government, Canadian Coast Guard	Yes	Yes	UNAUTHORIZED	④
83	157.175	161.775	D	Canadian Coast Guard	Yes	Yes	CANADIAN CG	
83A	157.175	157.175	S	U.S. Government, Canadian Coast Guard	Yes	Yes	UNAUTHORIZED	④
83B	---	161.775	S	Canadian Coast Guard, RX Only	-----	-----	CANADIAN CG	
84	157.225	161.825	D	Public Correspondence, Marine Operator	No	Yes	TELEPHONE	
85	157.275	161.875	D	Public Correspondence, Marine Operator	No	Yes	TELEPHONE	
86	157.325	161.925	D	Public Correspondence, Marine Operator	No	Yes	TELEPHONE	
87	157.375	161.975	D	Public Correspondence, Marine Operator	No	Yes	TELEPHONE	
88	157.425	162.025	D	Public Correspondence, Marine Operator	No	Yes	TELEPHONE	

Special Notes on Canada Channel Usage

- ①. LOW POWER (1 W) only.
- ②. Receive Only.
- ③. LOW POWER (1 W) initially. Override to HIGH POWER by holding down H/L key before transmitting. Used normally in bridge-to-bridge communications.
- ④. Lightly shaded simplex channels 21A, 23A, 61A, 64A, 81A, 82A, and 83A cannot be lawfully used in Canada waters unless special authorization is obtained from the Canadian Coast Guard. Not for use by the general public.

- ⑤ The letter "A" illuminated by the channel number indicates the Canada channel is simplex. This same channel is always duplex when selecting International. There is no "A" reference for International channels. The letter "B" is only used for some Canadian "Receive only" channels.
- ⑥ Channel 70 is designated for use exclusively for Digital Selective Calling (DSC), such as Distress, Safety, and Ship Calls. No voice communication is allowed on CH70. This channel is only available on DSC enabled radios.

Note: The CANADA mode is not legal to use in U.S. waters.

KEY: S = Simplex operating channel; D = Duplex operating channel.

C-4 US & Canada WEATHER Channels

CH	RX (MHz)	TRAFFIC TYPE	NAME	REMARK
WX01	162.550	NOAA Weather Channel	NOAA WX	RX only
WX02	162.400	NOAA Weather Channel	NOAA WX	RX only
WX03	162.475	NOAA Weather Channel	NOAA WX	RX only
WX04	162.425	NOAA Weather Channel	NOAA WX	RX only
WX05	162.450	NOAA Weather Channel	NOAA WX	RX only
WX06	162.500	NOAA Weather Channel	NOAA WX	RX only
WX07	162.525	NOAA Weather Channel	NOAA WX	RX only
WX08	161.650	CANADIAN Weather Channel	CANADA WX	RX only
WX09	161.775	CANADIAN Weather Channel	CANADA WX	RX only
WX10	163.275	NOAA Weather Channel	NOAA WX	RX only

Appendix D - EU VHF Marine Channel Charts

The following channel charts are provided for reference only and may not be correct for all regions. It is the operators responsibility to ensure correct channels and frequencies are used for local regulations. For specific channel information for your country, please refer to local authorities.

D-1 EU International Channel Chart

CH	TX (MHz)	RX (MHz)	MODE	TRAFFIC TYPE	SHIP TO SHIP	SHIP TO SHORE	NAME TAG	REMARK
01	156.050	160.650	D	Public Correspondence, Port Op	No	Yes	PHONE-PORTOP	
02	156.100	160.700	D	Public Correspondence, Port Op	No	Yes	PHONE-PORTOP	
03	156.150	160.750	D	Public Correspondence, Port Op	No	Yes	PHONE-PORTOP	
04	156.200	160.800	D	Public Correspondence, Port Op	No	Yes	PHONE-PORTOP	
05	156.250	160.850	D	Public Correspondence, Port Op	No	Yes	PHONE-PORTOP	
06	156.300	156.300	S	Inter-ship Safety	Yes	No	SAFETY	
07	156.350	160.950	D	Public Correspondence, Port Op	No	Yes	PHONE-PORTOP	
08	156.400	156.400	S	Commercial (inter-ship only)	Yes	No	SHIP-SHIP	
09	156.450	156.450	S	Inter-ship	Yes	Yes	SHIP-SHIP	
10	156.500	156.500	S	Inter-ship	Yes	Yes	SHIP-SHIP	
11	156.550	156.550	S	Port Operations	Yes	Yes	PORT OPS	
12	156.600	156.600	S	Port Operations	Yes	Yes	PORT OPS	
13	156.650	156.650	S	Inter-ship Navigation Safety (bridge-to-bridge)	Yes	No	SAFETY COM	
14	156.700	156.700	S	Port Operations	Yes	Yes	PORT OPS	
15	156.750	156.750	S	Inter-ship	Yes	Yes	PORT OPS	⊙ 1W only
16	156.800	156.800	S	International Distress, Safety, and Calling	Yes	Yes	DISTRESS	
17	156.850	156.850	S	Inter-ship	Yes	Yes	PORT OPS	⊙ 1W only
18	156.900	161.500	D	Public Correspondence, Port Op	No	Yes	PHONE-PORTOP	
19	156.950	161.550	D	Public Correspondence, Port Op	No	Yes	PHONE-PORTOP	
20	157.000	161.600	D	Public Correspondence, Port Op	No	Yes	PHONE-PORTOP	
21	157.050	161.650	D	Public Correspondence, Port Op	No	Yes	PHONE-PORTOP	
22	157.100	161.700	D	Public Correspondence, Port Op	No	Yes	PHONE-PORTOP	
23	157.150	161.750	D	Public Correspondence, Port Op	No	Yes	PHONE-PORTOP	
24	157.200	161.800	D	Public Correspondence, Port Op	No	Yes	PHONE-PORTOP	
25	157.250	161.850	D	Public Correspondence, Port Op	No	Yes	PHONE-PORTOP	
26	157.300	161.900	D	Public Correspondence, Port Op	No	Yes	PHONE-PORTOP	
27	157.350	161.950	D	Public Correspondence, Port Op	No	Yes	PHONE-PORTOP	
28	157.400	162.000	D	Public Correspondence, Port Op	No	Yes	PHONE-PORTOP	
60	156.025	160.625	D	Public Correspondence, Port Op	No	Yes	PHONE-PORTOP	
61	156.075	160.675	D	Public Correspondence, Port Op	No	Yes	PHONE-PORTOP	

62	156.125	160.725	D	Public Correspondence, Port Op	No	Yes	PHONE-PORTOP	
63	156.175	160.775	D	Public Correspondence, Port Op	No	Yes	PHONE-PORTOP	
64	156.225	160.825	D	Public Correspondence, Port Op	No	Yes	PHONE-PORTOP	
65	156.275	160.875	D	Public Correspondence, Port Op	No	Yes	PHONE-PORTOP	
66	156.325	160.925	D	Public Correspondence, Port Op	No	Yes	PHONE-PORTOP	
67	156.375	156.375	S	Commercial, bridge-to-bridge	Yes	No	SHIP-SHIP	
68	156.425	156.425	S	Port Operations	Yes	No	PORT OPS	
69	156.475	156.475	S	Inter-ship	Yes	Yes	SHIP-SHIP	
70	156.525	156.525	-	Digital Selective Calling - DSC	-----	-----	DSC	②
71	156.575	156.575	S	Port Operations	Yes	Yes	PORT OPS	
72	156.625	156.625	S	Inter-ship	Yes	No	SHIP-SHIP	
73	156.675	156.675	S	Inter-ship	Yes	Yes	SHIP-SHIP	
74	156.725	156.725	S	Port Operations	Yes	Yes	PORT OPS	
75	156.775	156.775	S	Port Operations	Yes	Yes	PORT OPS	① 1W only
76	156.825	156.825	S	Port Operations	Yes	Yes	PORT OPS	① 1W only
77	156.875	156.875	S	Inter-ship	Yes	No	SHIP-SHIP	
78	156.925	161.525	D	Public Correspondence, Port Op	No	Yes	PHONE-PORTOP	
79	156.975	161.575	D	Public Correspondence, Port Op	No	Yes	PHONE-PORTOP	
80	157.025	161.625	D	Public Correspondence, Port Op	No	Yes	PHONE-PORTOP	
81	157.075	161.675	D	Public Correspondence, Port Op	No	Yes	PHONE-PORTOP	
82	157.125	161.725	D	Public Correspondence, Port Op	No	Yes	PHONE-PORTOP	
83	157.175	161.775	D	Public Correspondence, Port Op	No	Yes	PHONE-PORTOP	
84	157.225	161.825	D	Public Correspondence, Port Op	No	Yes	PHONE-PORTOP	
85	157.275	161.875	D	Public Correspondence, Port Op	No	Yes	PHONE-PORTOP	
86	157.325	161.925	D	Public Correspondence, Port Op	No	Yes	PHONE-PORTOP	
87	157.375	157.375	S	Port Operations	No	Yes	PORT OPS	③
88	157.425	157.425	S	Port Operations	No	Yes	PORT OPS	③

Special Notes on EU International Channel Usage

- ①. LOW POWER (1W) only.
- ②. Channel 70 is designated for use exclusively for Digital Selective Calling (DSC), such as Distress, Safety, and Ship Calls. No voice communication is allowed on CH70. This channel is only available on DSC enabled radios.
- ③. Maybe Duplex in some regions

KEY: S = Simplex operating channel; D = Duplex operating channel.

D-2 Inland Waterways Country Specific table - ATIS ON

For specific channel information for your country, please refer to local authorities.

CH	SPECIFIC FOOT-NOTES	TRANSMITTING FREQUENCY (MHZ)		SHIP-TO-SHIP	SHIP-TO PORT	NAUTICAL INFORMATION
		SHIP	LAND			
60	a)	156.025	160.625			x
01	a)	156.05	160.65			x
61	a)	156.075	160.675			x
02	a)	156.1	160.7			x
62	a)	156.125	160.725			x
03	a)	156.15	160.75			x
63	a)	156.175	160.775			x
04	a)	156.2	160.8			x
64	a)	156.225	160.825			x
05	a)	156.25	160.85			x
65	a)	156.275	160.875			x
06	a) b)	156.3	156.3	x		
66	a)	156.325	160.925			x
07	a)	156.35	160.95			x
67	a) c)	156.375	156.375			x
08	a) q)	156.4	156.4	x		
68	a)	156.425	156.425			x
09	a) b) c)	156.45	156.45			x
69	a)	156.475	156.475			x
10	e)	156.5	156.5	x		
70	a)	156.525	156.525	Digital selective calling for distress, safety and calling		
11		156.55	156.55		x	
71		156.575	156.575		x	
12		156.6	156.6		x	
72	a) r)	156.625	156.625	x		
13	f)	156.65	156.65	x		
73	f) g)	156.675	156.675			x
14	q)	156.7	156.7		x	
74	a)	156.725	156.725		x	
15	h)	156.75	156.75			x
75	o)	156.775	156.775		x	
16	i)	156.8	156.8			x
76	j) d) o)	156.825	156.825			x
17	h)	156.85	156.85			x

77	a) k)	156.875	156.875	x		
18		156.9	161.5			x
78		156.925	161.525			x
19		156.95	161.55			x
79	a)	156.975	161.575			x
20		157	161.6			x
80		157.025	161.625			x
21	a)	157.05	161.65			x
81	a)	157.075	161.675			x
22		157.1	161.7			x
82	l) m)	157.125	161.725			x
23	m)	157.15	161.75			x
83	a) m)	157.175	161.775			x
24	m)	157.2	161.8			x
84	m)	157.225	161.825			x
25	m)	157.25	161.85			x
85	a) m)	157.275	161.875			x
26	m)	157.3	161.9			x
86	a) m)	157.325	161.925			x
27	m)	157.35	161.95			x
87	a) d)	157.375	157.375			x
28	m)	157.4	162			x
88	a) p)	157.425	157.425			x
ALS 1	a) n)	161.975	161.975			
ALS 2	a) n)	162.025	162.025			

General remarks to Country Specific table:

- 1 The channels for service categories ship-to-ship and nautical information may also be used for vessel traffic -systems by traffic centres.
- 2 In some countries, frequencies certain channels are used for an other service category or other radio services. These countries are Austria, Bulgaria, Croatia, the Federal Republic of Yugoslavia, Hungary, Moldova, Romania, the Russian Federation, the Slovak Republic, the Czech Republic (with exemption of channels 08, 09, 72, 74 and 86), Ukraine and the Federal Republic of Yugoslavia. The Administrations concerned should make any possible attempt to make these frequencies channels as soon as possible available for the radiotelephone service on Inland Waterways and/or the required service category.

Explanation of specific footnotes in Country Specific table:

- a. In the countries mentioned under remark 2, it is strictly prohibited to use this channel.
- b. This channel is not allowed to be used between Rhine km 150 and km 350.
- c. In the Netherlands, this channel is used by its on-scene communications during safety operations on the North Sea, IJsselmeer, Waddenzee, Ooster- and Westerschelde.
- d. This channel may also be used for piloting, mooring, tugging and for other nautical purposes.
- e. This channel is the first ship-to-ship channel, unless the competent authority has designated an other channel. In the countries mentioned under remark 2, it is allowed that the output power is set to a value between 6 and 25 W until 1 January 2005.
- f. In the countries mentioned under remark 2, this channel is used for service category ship-to-port authorities.
- g. In the Netherlands, this channel is used by its national coastguard for communications during oil pollution operations on the North Sea and for safety messages for the North Sea, Waddenzee, IJsselmeer, Ooster- and Westerschelde.
- h. This channel may be used only for service category on-board communications.
- i. This channel may be used only for communications between seagoing vessels and participating land stations in case of distress and safety communications within the maritime sea-areas. In the countries mentioned under remark 2, this channel may be used only for distress, safety and calling.
- j. The output power shall be reduced automatically to a value between 0.5 and 1 W.
- k. This channel may be used for communications with a social character.
- l. In the Netherlands and Belgium, this channel may be used for transmitting messages concerning bunkering and victualling. The output power has to be reduced manually to a value between 0.5 and 1 W.
- m. This channel may also be used for public correspondence.
- n. This channel will be used for an automatic ship identification and surveillance system (AIS) capable of providing worldwide operating on seas and Inland Waterways.
- o. The availability of this channel is on a voluntary basis. All existing equipment shall be capable to of operating on this channel within a ten-year period after the entry into force of this Arrangement.
- p. After permission of the competent authority, this channel may be used only for special events on a temporary basis.
- q. In the Czech Republic this channel is used for service category nautical information.
- r. In the Czech Republic this channel is used for service category ship-to-port authorities.

D-3 Special Channels ²

CH	SEND (MHz)	RECEIVE (MHz)	TRAFFIC TYPE	SHIP TO SHIP	SHIP TO SHORE	NAME TAG
00 ¹	156.000	156.000	UK Coast Guard Users	Yes	Yes	UK COAST GRD
M1	157.425	157.850	UK Marina Channel M1	Yes	Yes	UK MARINA
M2	161.425	161.425	UK Marina Channel M2	Yes	Yes	UK MARINA
31	157.550	162.150	INT'L, Duplex (Holland)	No	Yes	NL MARINA
96H	162.425	162.425	INT'L (Belgium)	No	Yes	BEL G MARINA
L1	155.500	155.500	INT'L (Skandinavia)	Yes	No	LEISURE 1
L2	155.525	155.525	INT'L (Skandinavia)	Yes	No	LEISURE 2
L3	155.650	155.650	INT'L (Skandinavia-- not in Denmark)	Yes	No	LEISURE3
F1	155.625	155.625	INT'L (Skandinavia)	Yes	No	FISHING 1
F2	155.775	155.775	INT'L (Skandinavia)	Yes	No	FISHING 2
F3	155.825	155.825	INT'L (Skandinavia) call back	Yes	No	FISHING 3
AIS1	161.975	161.975	AIS1	-----	-----	-----
AIS2	162.025	162.025	AIS2	-----	-----	-----

Note:

1. Lightly Shaded Simplex channel CH00 is only available in the UK to Coast Guard users with written authorization.
2. The special channels above maybe fitted to your radio. These are only licensed for use in the country indicated. No attempt should be made to use them in any other country.

Countries of Intended use in the EU:

AT - Austria	HU - Hungary	PL - Poland
BE - Belgium	IS - Iceland	PT - Portugal
BG - Bulgaria	IE - Ireland	RO - Romania
CY - Cyprus	IT - Italy	SK - Slovakia
CZ - Czech Republic	LI - Liechtenstein	SI - Slovenia
DK - Denmark	LV - Latvia	ES - Spain
EE - Estonia	LT - Lithuania	SE - Sweden
FI - Finland	LU - Luxembourg	CH - Switzerland
FR - France	MT - Malta	TR - Turkey
DE - Germany	NL - Netherlands	UK - United Kingdom
GR - Greece	NO - Norway	



SIMRAD

CE1177ⓘ