

SRG-150DN/250DN

DESK Type [150W/250W] MF/HF DSC, NBDP SYSTEM

Compliant with ITU (ITU-R M.493-14, M.541-10),
IMO and GMDSS standard.

NEW COLOR LCD



MF/HF DSC, NBDP SYSTEM

SRG-150DN/250DN

DESK Type [150W/250W] MF/HF DSC, NBDP SYSTEM

FEATURES

- Compliant with ITU (ITU-R M493-14, M541-10), IMD and GMDSS standard.
- Improvement of sound quality, which applied with new conceptual SYNTHESIZE technology and noise-free realization.
- Implements a digital filter using DSP, eliminates external noise and noise generated by inside of the ship, significantly improves call quality.
- Compact size with simplified key and dial for the maximized and easy operations.
- Designed as one-unit DSC and W/K receiver built in the desktop of transceiver.
- Installed with 10.4-inch color LCD for easy message reading of NBDP TERMINAL.
- Each function and frequency are easy to read with the adoption of liquid crystal display
- Available with quick scan function for the variation of transmission output, frequencies and channels by group or individually.
- Available MEMORY with 100 DSC transmitting messages (100 MEMORY FILE EDIT).
- Available MEMORY with 100 DSC receiving messages (Distress: 50 messages and Ordinary: 50 messages).
- Installed a built-in internal speaker (Optional external speaker available).

SPECIFICATIONS

GENERAL

- Frequency range: TX: 1.6MHz ~ 27.5MHz, 10Hz STEP
RX: 500kHz ~ 29.9999MHz, 10Hz STEP
- TX/RX channel: ITU channel, 300 memory channels
- Frequency deviation: Within ± 10 Hz
- Type of emission: J3E, F1B, J2B
- Communication method: Simplex and Semi-duplex
- Operating temperature, Humidity: $-15^{\circ}\text{C} \sim +55^{\circ}\text{C}$, 95%
- Power supply: DC24V $\pm 15\%$
- Current: SRG-150DN 2.0A at receiving, 15A at transmitting
SRG-250DN 2.0A at receiving, 25A at transmitting

TRANSMITTER

- Type of emission and output: SRG-150DN J3E, J2B (150W)
SRG-250DN J3E, J2B (250W)
- Modulation system: Low power stage balanced modulation system
- Occupied frequency bandwidth: J3E 3KHz, J2B within 0.5KHz
- 2TONE distress signal: 1300Hz, 2100Hz

RECEIVER

- Receiving sensitivity: J3E, F1B, J2B $3\mu\text{V}/\text{S}/\text{N}$ 20dB 250mW
- Intermediate frequency: 64.455MHz, 455KHz
- Overall distortion and noise: More than 20dB
- Input impedance: 50 Ω

DSC WATCH KEEPING RECEIVER

- Frequency: 2187.5, 4207.5, 6312, 8414.5, 12577, 16804.5KHz
- Type of emission: F1B
- Frequency shift keying: 1700 ± 85 Hz (Mark: 1615Hz, Space: 1785Hz)
- Data transfer speed: 100 baud
- Frequency tolerance: 10Hz

NBDP

- Protocol: CCIR Recommendations 625, 476-4, 490, 491, 492-3 and F130
- Communication mode: ARQ (Automatic repeat request system)
CFEC (One direction ERROR correction: all broadcast)
SFEC (One direction ERROR correction: selective broadcast)

- Memory capacity: 16MB
- Intermediate frequency: 1700Hz
- Modulation speed: 100BAUD (ARQ FEC MODE)
- Modulation system: AFSK
- Frequency deviation: Within ± 0.5 Hz

NBDP COMPONENTS

- NBDP TERMINAL (SN-100)
- PRINTER (JP-3750 & HP-283)
- KEY BOARD (SPR-8630)

DIMENSIONS

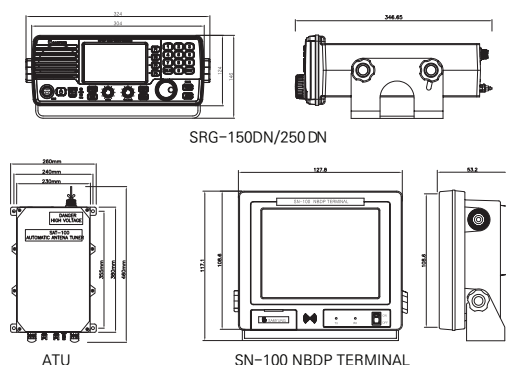

CONFIGURATION

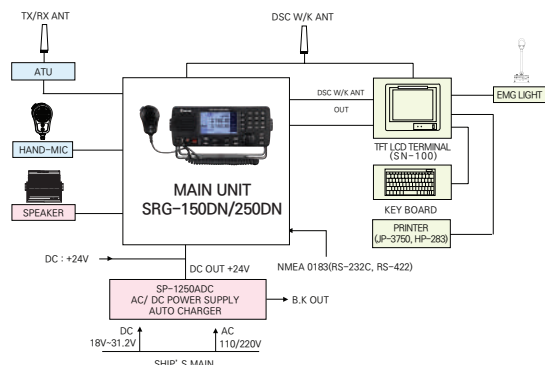

 **SAMYUNG ENC Co., Ltd.**

69, Sangri-Ro, Youngdo-Gu, Busan, Korea, 49089(Dongsam-Dong)

Head Office : +82 51-601-6666(Rep) Fax : +82 51-412-6616
Marketing&Service Division : +82 51-601-5555(Rep) Fax : +82 51-413-4446, 601-5540
+82 1577-0198(ARS) Fax : +82 51-416-5515

C/S Center : overseas@samyungenc.com(Overseas Marketing&Service Team)



ISO 9001:2009
Certificate No. : RQM0645



※Specification is subject to change without pre-notice