

SIMRAD

HS70

User Manual

ENGLISH



Preface

Disclaimer

As Navico is continuously improving this product, we retain the right to make changes to the product at any time which may not be reflected in this version of the manual. Please contact your nearest distributor if you require any further assistance.

It is the owner's sole responsibility to install and use the instrument and transducers in a manner that will not cause accidents, personal injury or property damage. The user of this product is solely responsible for observing safe boating practices.

NAVICO HOLDING AS AND ITS SUBSIDIARIES, BRANCHES AND AFFILIATES DISCLAIM ALL LIABILITY FOR ANY USE OF THIS PRODUCT IN A WAY THAT MAY CAUSE ACCIDENTS, DAMAGE OR THAT MAY VIOLATE THE LAW.

Governing Language: This statement, any instruction manuals, user guides and other information relating to the product (Documentation) may be translated to, or has been translated from, another language (Translation). In the event of any conflict between any Translation of the Documentation, the English language version of the Documentation will be the official version of the Documentation.

This manual represents the product as at the time of printing. Navico Holding AS and its subsidiaries, branches and affiliates reserve the right to make changes to specifications without notice.

Compliance

The HS70 complies with the following regulations:

- FCC Part 15, Subpart B
- IEC 60945 (CE)

For further compliance information please refer to our website: www.simrad-yachting.com

FCC Statement

This device complies with part 15 of the FCC Rules. Operation is subject to the following two conditions: (1) This device may not cause harmful interference, and (2) this device must accept any interference received, including interference that may cause undesired operation.

- **Note:** This equipment has been tested and complies with the limits for a Class B digital device, pursuant to Part 15 of the FCC Rules. These limits are designed to provide reasonable protection against harmful interference in a normal installation. This equipment generates, uses and can radiate radio frequency energy and, if not installed and used in accordance with the instructions, may cause harmful interference to radio communications. However, there is no guarantee that interference will not occur in a particular installation. This device must accept any interference received, including interference that may cause undesired operation.

If this equipment does cause harmful interference to radio or television reception, which can be determined by turning the equipment off and on, the user is encouraged to try to correct the interference by one or more of the following measures:

- Reorient or relocate the receiving antenna
- Increase the separation between the equipment and receiver
- Connect the equipment into an output on a circuit different from that to which the receiver is connected
- Consult the dealer or an experienced technician for help

- **Note:** A shielded cable must be used when connecting a peripheral to the serial ports.

Changes or modifications not expressly approved by the manufacturer could void the user's authority to operate the equipment.

Copyright

Copyright © 2011 Navico Holding AS.

Warranty

The warranty card is supplied as a separate document.

In case of any queries, refer to the our website: www.simrad-yachting.com

About this manual

This manual is a reference guide for installing and using the Simrad HS70.

Important text that requires special attention from the reader is emphasized as follows:

→ **Note:** Used to draw the reader's attention to a comment or some important information.

⚠ Warning: Used when it is necessary to warn personnel that they should proceed carefully to prevent risk of injury and/or damage to equipment/personnel.

Contents

1	Introduction
1	Overview
1	Parts
2	Installation
2	Mounting Location
2	Mounting Orientation
3	Mounting Options
5	Connecting the cable
5	Ports
7	Default Parameters
8	Operation
8	GPS Overview
8	HS70 Overview
10	Troubleshooting
11	Parts list
11	Included in package
11	Assessories
11	Spare parts
12	Specifications
12	TGPS sensor specifications
12	Communication specifications
13	Power specifications
13	Mechanical specifications
13	Environmental specifications
14	HS70 Dimensions
15	PGNs with the HS70 in NMEA 2000 mode
18	NMEA 0183 messages

2

Introduction

Overview

The HS70 is a complete GPS compass and positioning system in a single enclosure that requires only one power/data cable connection. With its NMEA 2000 and NMEA 0183 support and ease of installation, the HS70 is the perfect solution for marine applications.

The HS70 is an integrated system that houses the following:

- Dual integrated GPS antennas
- Power supply
- Single axis gyro
- Tilt sensor on each axis (X and Y axes)
- Standard NMEA 2000 port (cable to be ordered separately)
- Standard NMEA 0183 port (cable to be ordered separately)

The gyro and tilt sensors are present to improve system performance and to provide backup heading information in the event that a GPS heading is not available due to signal blockage.

The HS70's GPS antennas are separated by 27.5 cm between their phase centers, resulting in better than 0.75° rms heading performance. The HS70 provides heading and positioning updates of up to 20 Hz and delivers positioning accuracy of better than 1.0 m 95% of the time when using differential GPS corrections from Space Based Augmentation Systems (SBAS).

Parts

An HS70 installation requires the following parts:

Part Name	Qty
HS70 receiver	1
NMEA 2000 or NMEA 0183 cable (not included, must be ordered separately)	1
4 fastening bolts and washers, M8 for fixed or pole mount (not included)	4
Plastic wraps for cable securing (not included)	-

2

Installation

Mounting Location

This section provides information on determining the best location for the HS70.

GPS Reception

When considering where to mount the HS70, consider the following GPS reception recommendations:

- Consider GPS (and hence SBAS) reception, ensuring there is a clear view of the sky available to the HS70 so the GPS and SBAS satellites are not masked by obstructions that may reduce system performance
- Since the HS70 computes a position based on the internal primary GPS antenna element, mount the HS70 where you desire a position with respect to the primary GPS antenna (located on the end opposite the recessed arrow on the underside of the enclosure)
- Locate any transmitting antennas away from the HS70 (refer illustration below) to ensure tracking performance is not compromised, giving you the best performance possible
- Make sure there is enough cable length to route into the vessel to reach a breakout box, terminal strip or NMEA 2000 T-connector
- Do not locate the antenna where environmental conditions exceed those specified in "Specifications" on page 12.



VHF Interference

VHF interference from such devices as cellular phones and radio transmitters may interfere with GPS operation. For example, if installing the HS70 near marine radios consider the following:

- VHF marine radio working frequencies (Channels 1 to 28 and 84 to 88) range from 156.05 to 157.40 MHz. The L1 GPS working center frequency is 1575.42 MHz. The bandwidth is +/- 2 MHz to +/- 10 MHz, which is dependent on the GPS antenna and receiver design
- VHF marine radios emit strong harmonics. The 10th harmonic of VHF radio, in some channels, falls into the GPS working frequency band, which may cause the SNR of GPS to degrade significantly
- The radiated harmonic signal strength of different brands/models varies
- Follow VHF radio manufacturers' recommendations on how to mount their radios and what devices to keep a safe distance away
- Handheld 5 W VHF radios may not provide suitable filtering and may interfere with the HS70's operation if too close

Ensure there are no nearby devices that may cause VHF interference. Use minimum distances from nearby VHF antenna as shown on the illustration.

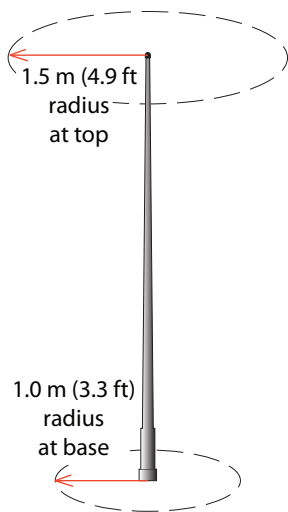

Mounting Orientation

The HS70 outputs heading, pitch, and roll readings. However, the relation of the antennas to the boat's axis determines whether you will need to enter a heading offset. The primary antenna is used for positioning and the primary and secondary antennas, working in conjunction, output heading, pitch, and roll values.

Mount the HS70 parallel to, and along the centerline of, the axis of the boat. This provides a true heading. In this orientation:

- You can enter a heading offset in a Simrad compatible head unit (AP24, AP28, AP70, AP80, IS20 Graphic/Combi, NSE, NSO, NSS) to calibrate the physical heading to the true heading of the vessel
- You will have an offset in the pitch/roll output if the unit is not installed in a horizontal plane

The figure shows recommended orientation and resulting signs of heading (H), pitch (P) and roll (R) values.

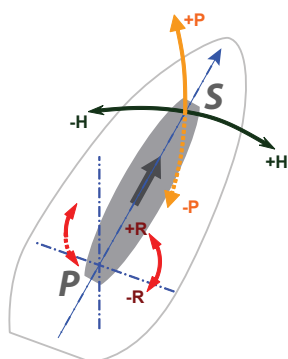

HS70 Alignment

The top of the HS70 enclosure incorporates sight design features to help you align the enclosure with respect to your vessel.

To use the sights, center the small post on the opposite side of the enclosure from you, within the channel made in the medallion located in the center of the enclosure top as shown in the figures below.

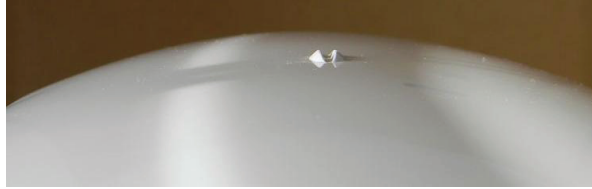

Alignment accuracy when looking through the long site is approximately +/- 1°

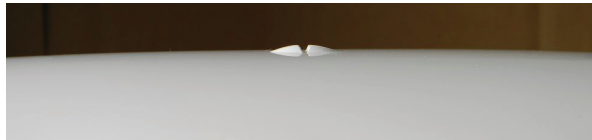

Alignment through the short site is approximately +/- 2.5°

Mounting Options

The HS70 allows for two different mounting options: fixed mount and pole mount. Refer "HS70 Dimensions" on page 14.

- Flush mount - The bottom of the HS70 contains four M8 holes for flush mounting the unit to a flat surface
- Pole mount - The bottom of the HS70 contains a mounting hole (1" thread, 0.9" depth) for easy pole mounting. Hand tighten until snug (do not overtighten). The set screws on the long sides of the base allow you to secure the HS70 in place (3/16" Allen wrench not included)

→ **Note:** Mounting accessories not included.

Cable mounting considerations

Before mounting the HS70 consider the following regarding power/data cable routing:

- Cable must reach an appropriate power source
- Cable may connect to a data storage device, computer, or other device that accepts GPS data
- Avoid running the cable in areas of excessive heat
- Keep cable away from corrosive chemicals
- Do not run the cable through door or window jams
- Keep cable away from rotating machinery
- Do not crimp or excessively bend the cable
- Avoid placing tension on the cable
- Remove unwanted slack from the cable at the HS70 end
- Secure along the cable route using plastic wraps

Warning: Improperly installed cable near machinery can be dangerous.

Fixed Mount

The bottom of the HS70 contains four holes for flush mounting the unit to a flat surface. See figure below. The flat surface may be something you fabricate per your installation, an off-the-shelf item (such as a radar mounting plate), or an existing surface on your vessel.

→ **Note:** HS70 does not include the mounting surface hardware. You must supply the appropriate fastening hardware required to complete the installation of the HS70.



→ **Note:** You do not necessarily need to orient the antenna precisely as you can enter a software offset to accommodate for any offset in heading measurement due to installation.

Before fix mounting the HS70

- Choose a location that meets the mounting location requirements
- Use the mounting template, mark and drill the mounting holes as necessary for the mounting surface
- Attach the cable to the HS70 and secure the cable

Fix mounting the HS70

1. Mark the mounting hole centers on the mounting surface.
2. Place the HS70 over the marks to ensure the planned hole centers align with the true hole centers (adjusting as necessary).
3. Use a center punch to mark the hole centers.
4. Drill the mounting holes with a 9 mm bit appropriate for the surface.
5. Place the HS70 over the mounting holes and insert the mounting screws through the bottom of the mounting surface and into the HS70.

⚠ Warning: When installing the HS70, hand tighten only. Damage resulting from overtightening is not covered by the warranty.

Pole Mount

Keep the following in mind when using a pole mount:

- Mounting hole is 1" thread, 0.9" depth
- Hand tighten until snug (do not overtighten) while ensuring correct orientation
- Use the set screws on the long sides of the base to secure the HS70 in place (3/16" Allen wrench not included)

⚠ Warning: Overtightening may damage the system. This is not covered under warranty.

Before pole mounting the HS70

- Install the HS70 parallel with the vessel's axis.
- Choose a location that meets the mounting location requirements.
- Attach the cable to the HS70 and secure the cable.

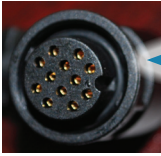

Connecting the cable

1. Align the cable connector keyway or the NMEA 2000 adapter with the HS70 connector key
2. Rotate the cable ring clockwise until it locks. The locking action is firm, but you will feel a positive “click” when it has locked
3. Securing the cable

Ports

NMEA 2000 Port

Powering the HS70 when used in a NMEA 2000 installation

To power the unit via NMEA 2000 connection, follow the standard procedure for powering of a NMEA 2000 network.

Connecting the HS70 to External Devices

For connecting NMEA 2000 devices, plug the serial-to-NMEA 2000 adapter into the HS70 and then attach a standard NMEA 2000 dropline cable to the adapter.

Insert the 12-pin connector of the adapter into the male end of the 12-pin connector on the HS70 by aligning the keys. Secure the adapter to the unit using the supplied screws (machine, 8-32, 1/2", PPHC, SS) and washer (washer, flat, #8, SS).

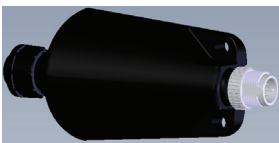

Refer “PGNs with the HS70 in NMEA 2000 mode” on page 15.

NMEA 0183

The HS70 offers position, heading, rate of turn, heave, time COG and SOG data, via NMEA 0183 port. In addition to outputting data, these ports are used for firmware upgrades.

Refer “NMEA 0183 messages” on page 18.

Powering the HS70 when used in a NMEA 0183 installation

For best performance use a clean and continuous power supply. The HS70 power supply features reverse polarity protection but will not operate with reverse polarity.

See “Power specifications” on page 13 for complete power specifications.

Before you power up the HS70 you must terminate the wires of the power cable as required. There are a variety of power connectors and terminals on the market from which to choose, depending on your specific requirements.

⚠ Warning: Do not apply a voltage higher than 36 VDC. This will damage the receiver and void the warranty.

To interface the HS70 power cable to the power source:

- Connect the red wire of the cable’s power input to DC positive (+)
- Connect the black wire of the cable’s power input to DC negative (-)

The HS70 will start when an acceptable voltage is applied to the power leads of the extension cable.

The HS70’s power supply is isolated from the communication lines and the PC-ABS plastic enclosure isolates the electronics mechanically from the vessel (addressing the issue of vessel hull electrolysis).

Power/Data Cable Considerations

The HS70 uses a single 15 m (49 ft) cable for power and data input/output.

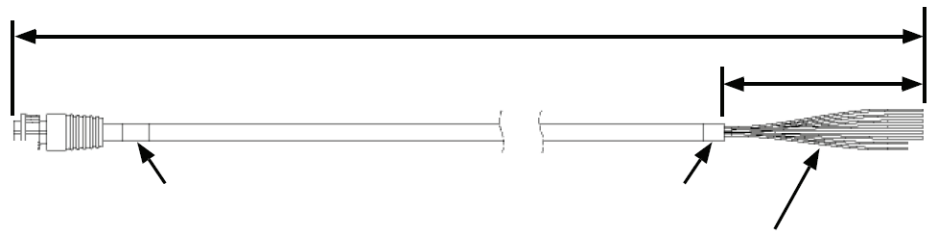

The receiver end of the cable is terminated with an environmentally sealed 12-pin connection while the opposite end is unterminated and requires field stripping and tinning.

Depending on the application and installation needs, you may need to shorten this cable. However, if you require a longer cable run than 15 m, you can bring the cable into a break-out box that incorporates terminal strips, within the vessel.

When lengthening the cable keep the following in mind:

- To lengthen the serial lines inside the vessel, use 20-gauge twisted pairs and minimize the additional wire length.
- When lengthening the power input leads to the HS70, ensure the additional voltage drop is small enough that your power system can continue to power the system above the minimum voltage of the system. Wire of 18-gauge or larger should also be used.
- Minimize RS-232 cable length to ensure reliable communication

Power/Data Cable Pinout Specifications

	Pin	Function	Wire Color	Comments
	1	Port C, RS-232 female DB9 pin 2, device out	White	NMEA 2000 only
	2	Port C, RS-232 female DB9 pin 3, device in	Green	
	3	N/C	N/C	
	4	N/C	N/C	
	5	Power input	Red	
	6	N/C	N/C	
	7	Signal ground	Yellow	
	8	Port A, RS-232 female DB9 pin 3, device in	Brown	NMEA 0183 only
	9	Port A, RS-232 female DB9 pin 2, device out	Blue	
	10	Power ground	Black	
	11	CH_GND	Drain	
	12	N/C	N/C	

Default Parameters

The table below provides details on the default port settings, available baud rates, differential age, elevation mask, and default differential mode.

Port	Baud Rate	NMEA Messages
Port A (NMEA 0183)	4800	GGA, HD, HEV, ROT, VTG, ZDA
Port C (RS-232)	57600	None, used for serial to NMEA 2000 adapter
Power RED (+) BLK (-)	6 - 36 V DC	

3

Operation

GPS Overview

For your convenience, both the GPS and SBAS operation of the HS70 features automatic operational algorithms. When powered for the first time, the HS70 performs a “cold start,” which involves acquiring the available GPS satellites in view and the SBAS differential service.

GPS Operation

The GPS receiver is always operating, regardless of the DGPS mode of operation. The following sections describe the general operation of the HS70’s internal GPS receiver.

- **Note:** Differential source and status have no impact on heading, pitch, or roll. They only have an impact on positioning and heave.

Automatic Tracking

The HS70’s internal GPS receiver automatically searches for GPS satellites, acquires the signals, and manages the navigation information required for positioning and tracking.

Receiver Performance

The HS70 works by finding four or more GPS satellites in the visible sky. It uses information from the satellites to compute a position within 4.0 m. Since there is some error in the GPS data calculations, the HS70 also tracks a differential correction. The HS70 uses these corrections to improve its position accuracy to better than 1.0 m.

There are two main aspects of GPS receiver performance:

- Satellite acquisition
- Positioning and heading calculation

When the HS70 is properly positioned, the satellites transmit coded information to the antennas on a specific frequency. This allows the receiver to calculate a range to each satellite from both antennas. GPS is essentially a timing system. The ranges are calculated by timing how long it takes for the signal to reach the GPS antenna. The GPS receiver uses a complex algorithm incorporating satellite locations and ranges to each satellite to calculate the geographic location and heading. Reception of any four or more GPS signals allows the receiver to compute three-dimensional coordinates and a valid heading.

Differential Operation

The purpose of differential GPS (DGPS) is to remove the effects of atmospheric errors, timing errors, and satellite orbit errors, while enhancing system integrity. Autonomous positioning capabilities of the HS70 will result in positioning accuracies of 4.0 m 95% of the time. In order to improve positioning quality to better than 1.0 m 95%, the HS70 is able to use differential corrections received through the internal SBAS demodulator.

Automatic SBAS Tracking

The HS70 automatically scans and tracks SBAS signals without the need to tune the receiver. The HS70 features two-channel tracking that provides an enhanced ability to maintain a lock on an SBAS satellite when more than one satellite is in view. This redundant tracking approach results in more consistent tracking of an SBAS signal in areas where signal blockage of a satellite is possible.

HS70 Overview

The HS70 provides accurate and reliable heading and position information at high update rates. To accomplish this task, the HS70 uses a high performance GPS receiver and two antennas for GPS signal processing. One antenna is designated as the primary GPS antenna and the other is the secondary GPS antenna. Positions computed by the HS70 are referenced to the phase center of the primary GPS antenna. Heading data references the vector formed from the primary GPS antenna phase center to the secondary GPS antenna phase center.

The heading arrow located on the bottom of the HS70 enclosure defines system orientation. The arrow points in the direction the heading measurement is computed (when the antenna is installed parallel to the fore-aft line of the vessel). The secondary antenna is directly above the arrow.

→ **Note:** The HS70 moving base station algorithm only uses GPS to calculate heading. Differential corrections are not used in this calculation and will not affect heading accuracy.

Supplemental Sensors

The HS70 has an integrated gyro and two tilt sensors. The gyro and tilt sensors are enabled by default. Each supplemental sensor may be individually enabled or disabled. Both supplemental sensors are mounted on the printed circuit board inside the HS70.

The sensors act to reduce the startup and reacquisition times. This improves the reliability and accuracy of selecting the correct heading solution by eliminating other possible, erroneous solutions. The table below provides a sensor operation summary.

Feature	Normal Operation	Coasting (no GPS)
Heading	GPS	Gyro
Heave	GPS	None
Pitch	GPS	Inertial sensor
Roll	Inertial sensor	Inertial sensor

4

Troubleshooting

Symptom	Possible Solution
Receiver fails to power	<ul style="list-style-type: none">• Verify polarity of power leads• Check integrity of power cable connectors• Check power input voltage (6 to 36 VDC)• Check current restrictions imposed by power source (minimum available should be > 1.0 A)
No data from HS70	<ul style="list-style-type: none">• Check receiver power status to ensure the receiver is powered (an ammeter can be used for this)• Ensure the baud rate (4800) of the HS70 matches that of the receiving device• Check integrity and connectivity of power and data cable connections
Random data from HS70	<ul style="list-style-type: none">• Ensure the baud rate of the HS70 matches that of the remote device
No GPS lock	<ul style="list-style-type: none">• Verify the HS70 has a clear view of the sky• Verify the lock status of GPS satellites in the Simrad compatible head unit (refer separate documentation)
No SBAS lock	<ul style="list-style-type: none">• Verify the HS70 has a clear view of the sky <p>Note: SBAS lock is only possible if you are in an appropriate SBAS region; currently, there is limited SBAS availability in the southern hemisphere.</p>
No heading or incorrect heading value	<ul style="list-style-type: none">• Heading is from primary GPS antenna to secondary GPS antenna, so the arrow on the underside of the HS70 should be directed to the bow side• Monitor the number of satellites and SNR values for both antennas in the Simrad head unit — at least four satellites should have strong SNR values

5

Parts list

Included in package

Description
HS70 Receiver
Serial to NMEA 2000 adapter
User manual
Mounting template

Assessories

Part no	Description
Refer Simrad price list	NMEA 2000 cables
000-10640-001	HS70 Power/NMEA 0183 cable, 15 m (49,2 ft)

Spare parts

There are no spare parts available for the HS70.

6

Specifications

TGPS sensor specifications

Item	Specification
Receiver type	L1, C/A code with carrier phase smoothing
Channels	Two 12-channel, parallel tracking (Two 10-channel when tracking SBAS)
SBAS tracking	2-channel, parallel tracking
Update rate	Standard 10 Hz, optional 20 Hz (position and heading)
Horizontal accuracy	< 1.0 m 95% confidence (DGPS ¹) < 4.0 m 95% confidence (autonomous, no SA ²)
Heading accuracy	< 0.75° rms Normal operation: GPS Coasting (no GPS): Gyro
Heave accuracy	< 30 cm rms ⁵ Normal operation: GPS Coasting (no GPS): None
Pitch accuracy	< 1.5° rms Normal operation: GPS Coasting (no GPS): Inertial sensor
Roll accuracy	< 1.5° rms using accelerometer Normal operation: Inertial sensor Coasting (no GPS): Inertial sensor
Rate of turn	90°/s maximum
Cold start	< 60 s typical (no almanac or RTC)
Warm start	< 20 s typical (almanac and RTC)
Hot start	< 1 s typical (almanac, RTC, and position)
Heading fix	< 10 s typical (valid position)
Compass safe distance	30 cm (11.8 in) ⁴
Maximum speed	1,850 kph (999 kts)
Maximum altitude	18,288 m (60,000 ft)

Communication specifications

Item	Specification
Serial ports	2 full-duplex RS-232
Baud rates	4800, 9600, 19200, 38400, 57600, 115200 (with programming cable - Simrad dealers only)
Correction I/O protocol	RTCM SC-104
Data I/O protocol	NMEA 0183, NMEA 2000

Power specifications

Item	Specification
Input voltage	NMEA 0183: 6 to 36 VDC NMEA 2000: 12V DC
Power consumption	~ 3 W nominal
Current consumption	320 mA @ 9 VDC 240 mA @ 12 VDC (NMEA 2000) 180 mA @ 16 VDC
Power isolation	Isolated to enclosure
Reverse polarity protection	Yes

Mechanical specifications

Item	Specification
Enclosure	UV resistant, white plastic, AES HW 600G, non-corrosive, self extinguishing
Dimensions (not including mounts)	41.7 L x 15.8 W x 6.9 H (cm) 16.4 L x 6.2 W x 2.7 H (in)
Weight	~ 1.50 kg (3.3 lb)

Environmental specifications

Item	Specification
Operating temperature	-30°C to +70°C (-22°F to +158°F)
Storage temperature	-40°C to +85°C (-40°F to +185°F)
Humidity	100% non-condensing
Vibration	IEC 60945
Compliance	FCC Part 15, Subpart B; IEC 60945 (CE)
Weather	IEC 60945, exposed

¹ Depends on multipath environment, number of satellites in view, satellite geometry, ionospheric activity, and use of SBAS

² Depends on multipath environment, number of satellites in view, satellite geometry, and ionospheric activity

³ IEC 60945 Standard

⁴ Based on a 40 second time constant

HS70 Dimensions

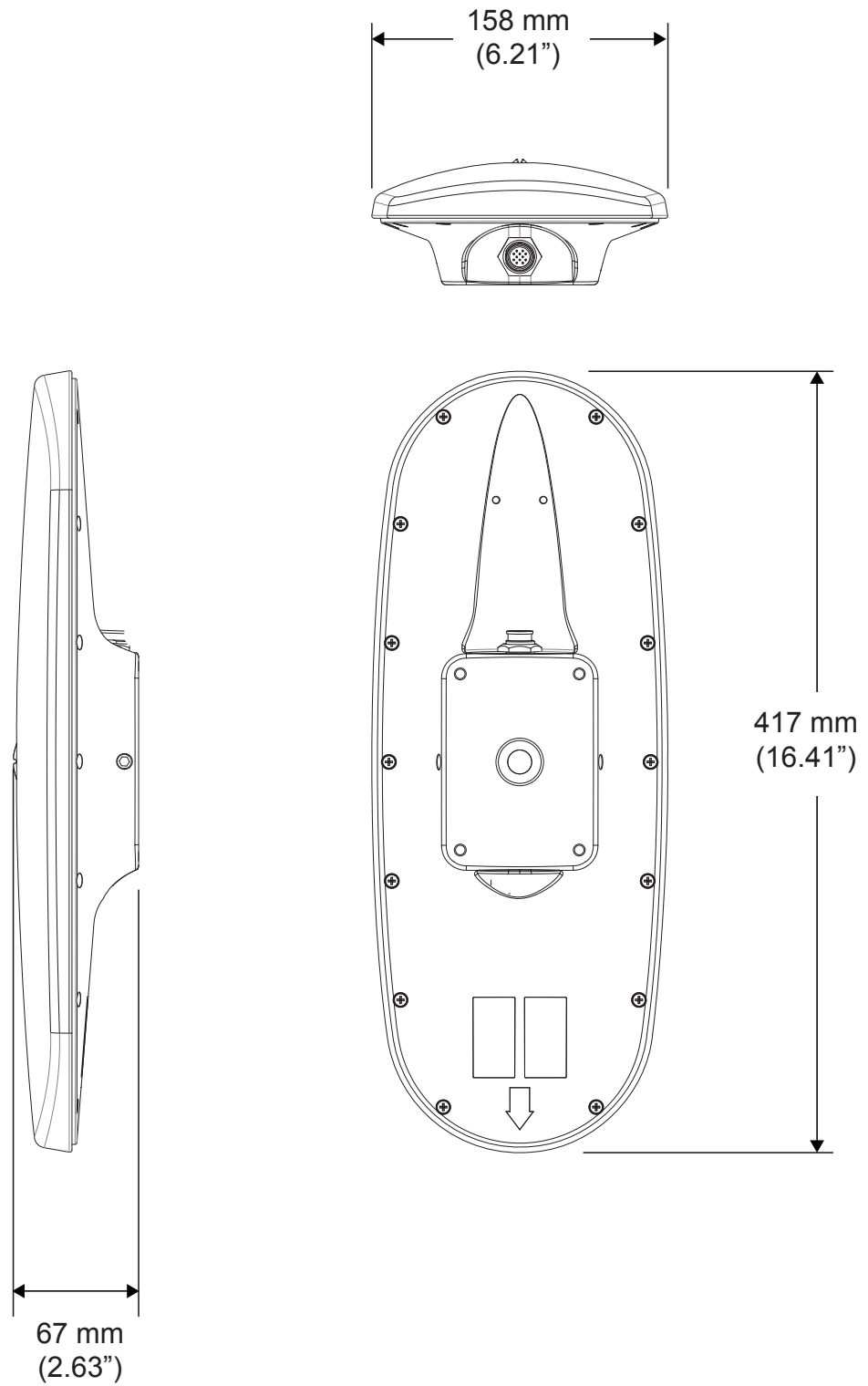

Max and Min Threads

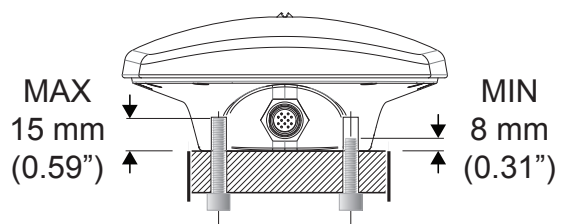

PGNs with the HS70 in NMEA 2000 mode

Received messages based on a request

PG No. (PGN)	Description	Level	Default Update Rate (msec)	Freq (Hz)
059392	ISO Acknowledgement Used to acknowledge the status of certain requests addressed to a specific ECU.	B	On Request	On Request
059904	ISO Request Request the transmission of a specific PGN, addressed or broadcast.	B	On Request	On Request
060928	ISO Address Claim Used to identify to other ECUs the address claimed by an ECU	B	On Request	On Request
126996	Production Information NMEA 2000 database version supported, manufacturer's product code, NMEA 2000 certification level, Load Equivalency number, and other product-specific information.	B	On Request	On Request
126464	Receive/Transmit PGNs group function The Transmit / Receive PGN List Group type of function is defined by first field. The message will be a Transmit or Receive PGN List group function.	B	On Request	On Request
129538	GNSS Control Status GNSS common satellite receiver parameter status.	B	On Request	On Request
129545	GNSS RAIM Output Used to provide the output from a GNSS receiver's Receiver Autonomous Integrity Monitoring (RAIM) process. The Integrity field value is based on the parameters set in PGN 129546 GNSS RAIM Settings.	B	On Request	On Request
129546	GNSS RAIM Settings Used to report the control parameters for a GNSS Receiver Autonomous Integrity Monitoring (RAIM) process.	B	On Request	On Request

Transmitted messages

PG No. (PGN)	Description	Level	Default Update Rate (msec)	Freq (Hz)
126992	System Time The purpose of this PGN is twofold: To provide a regular transmission of UTC time and date. To provide synchronism for measurement data.	B	1000	1
127250	Vessel Heading Heading sensor value with a flag for True or Magnetic. If the sensor value is Magnetic, the deviation field can be used to produce a Magnetic heading, and the variation field can be used to correct the Magnetic heading to produce a True heading.	B	100	10
127251	Rate of Turn Rate of change of the Heading.	B	100	10
127257	Attitude Provides a single transmission that describes the position of a vessel relative to both horizontal and vertical planes. This would typically be used for vessel stabilization, vessel control and onboard platform stabilization.	B	1000	1
127258	Magnetic Variation Message for transmitting variation. The message contains a sequence number to allow synchronization of other messages such as Heading or Course over Ground. The quality of service and age of service are provided to enable recipients to determine an appropriate level of service if multiple transmissions exist.		1000	1
128259	Speed Provides a single transmission that describes the motion of a vessel.	B	1000	1
129025	Position, Rapid Update Provides latitude and longitude referenced to WGS84. Being defined as single frame message, as opposed to other PGNs that include latitude and longitude and are defined as fast or multi-packet, this PGN lends itself to being transmitted more frequently without using up excessive bandwidth on the bus for the benefit of receiving equipment that may require rapid position updates.	B	100	10
129026	COG & SOG, Rapid Update Single frame PGN that provides Course Over Ground (COG) and Speed Over Ground (SOG).	B	250	4

PG No. (PGN)	Description	Level	Default Update Rate (msec)	Freq (Hz)
129027	<p>Position Delta, High Precision Rapid Update</p> <p>The "Position Delta, High Precision Rapid Update" Parameter Group is intended for applications where very high precision and very fast update rates are needed for position data. This PGN can provide delta position changes down to 1 mm with a delta time period accurate to 5 msec.</p> <p>B 100 10</p>	B	100	10
129028	<p>Altitude Delta, High Precision Rapid Update</p> <p>The "Altitude Delta, High Precision Rapid Update" Parameter Group is intended for applications where very high precision and very fast update rates are needed for altitude and course over ground data. This PG can provide delta altitude changes down to 1 millimeter, a change in direction as small as 0.0057°, and with a delta time period accurate to 5 msec.</p>	B	100	10
129029	<p>GNSS Position Data</p> <p>Conveys a comprehensive set of Global Navigation Satellite System (GNSS) parameters, including position information.</p>	B	1000	1
129033	<p>Time & Date</p> <p>Single transmission that provides UTC time, UTC Date, and Local Offset.</p>	B	1000	1
129539	<p>GNSS DOPs</p> <p>Provides a single transmission containing GNSS status and dilution of precision components (DOP) that indicate the contribution of satellite geometry to the overall positioning error. There are three DOP parameters reported: horizontal (HDOP), Vertical (VDOP), and time (TDOP).</p>	B	1000	1
129540	<p>GNSS Sats in View</p> <p>GNSS information on current satellites in view tagged by sequence ID. Information includes PRN, elevation, azimuth, SNR, defines the number of satellites; defines the satellite number and the information.</p>	B	1000	1

NMEA 0183 messages

Message	Info Type	Description	IEC Approved Message	Freq (Hz)
\$GPGGA	P	GPS position and fix data	Yes	1
*\$GPHDG	H	Magnetic deviation and variation for calculating magnetic or true heading	Yes	1
*\$GPHDT	H	GPS-derived true heading	Yes	10
\$GPHEV	H	Heave value (in meters)	Yes	1
*\$GPROT	H	GPS-derived rate of turn (ROT)	Yes	10
\$GPVTG	V	COG and ground speed	Yes	1
\$GPZDA	V	Time and date	Yes	1

→ **Note:** The GP of the message is the talker ID.



LOWRANCE

SIMRAD

B&G

www.bandg.com
www.simrad-yachting.com
www.lowrance.com