

MR1306UA

FULLY MARINIZED
MP3-COMPATIBLE DIGITAL MEDIA RECEIVER
WITH USB AND SD MEMORY CARD PORTS AND FRONT PANEL AUX INPUT

12.2012

BOSS[®]

AUDIO SYSTEMS

3451 Lunar Court • Oxnard, CA 93030

www.bosssaudio.com

800.999.1236

tech support: www.bosssaudio.com/support



iPod[®] is a trademark of Apple, Inc.
registered in the U.S. and other countries.

USER'S MANUAL MR1306UA

FULLY MARINIZED
MP3-COMPATIBLE DIGITAL MEDIA RECEIVER
WITH USB AND SD MEMORY CARD PORTS AND FRONT PANEL AUX INPUT

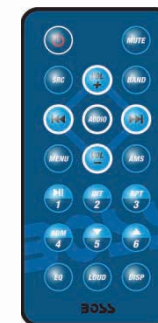

BOSS[®]

AUDIO SYSTEMS

Boss Audio Systems is not affiliated with Apple, Inc.

INSTRUCTION MANUAL

CAR RADIO RECEIVER / MP3 PLAYER

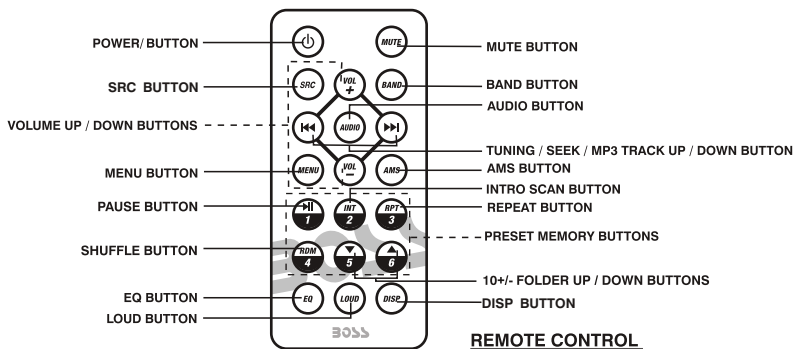
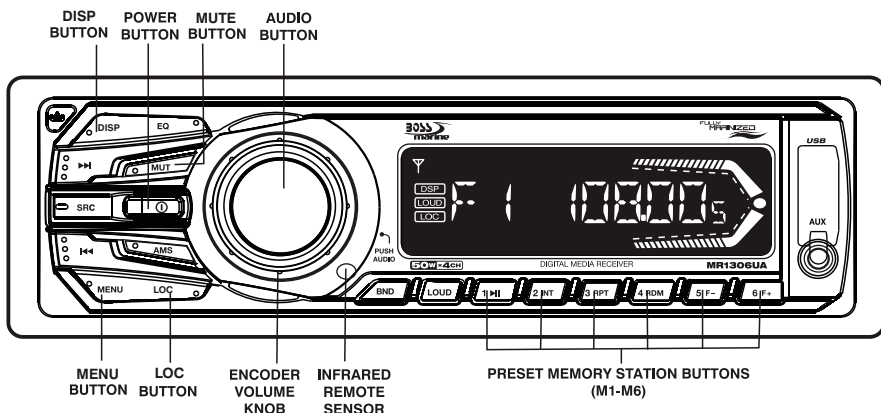
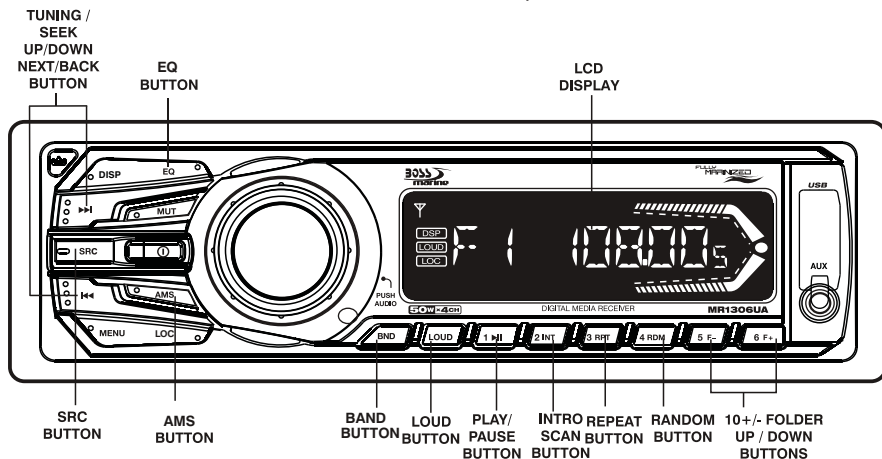

INSTALLATION

- Before final installation, connect the wiring temporarily and make sure it is all working properly.
- Use only the parts included with the unit to ensure proper installation. The use of unauthorized parts can cause malfunctions.
- This item must be installed by an authorized dealer in order to keep the warranty valid.
- Install the unit where it does not get in the driver's way and cannot injure the passenger if there is a sudden stop, like an emergency stop.
- Avoid installing the unit where it would be subject to high temperature, such as direct sunlight, or hot air, heater or where it would be subject to dust dirt or excessive vibration.
- Be sure to remove the front panel before installing the unit.

DIN FRONT/REAR-MOUNT

This unit can be properly installed either from Front (conventional DIN Front-mount) or Rear (DIN Rear-mount installation, utilizing threaded screw holes at the sides of the unit chassis). For details, refer to the following illustrated installation methods A and B.

- DIN FRONT-MOUNT (Method A)

Installation the unit

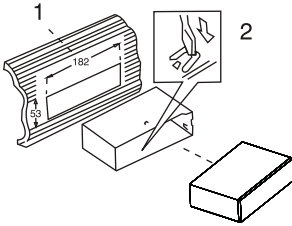

1. Dashboard
2. Holder

After inserting the half sleeve into the dashboard, select the appropriate tab according to the thickness of the dashboard material and bend them inwards to secure the holder in place.

Removing the unit

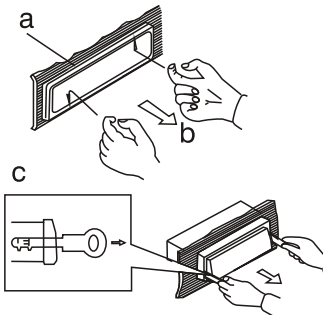

- a. Frame
- b. Insert fingers into the groove in the front of frame and pull out to remove the frame. (When re-attaching the frame, point the side with a groove down wards and attach it.)
- c. Insert the levers supplied with the unit into the grooves at both sides of the unit as shown in figure until they click. Pulling the levers makes it possible to remove the unit from the dashboard.

- DIN REAR-MOUNT (METHOD B)

Installation using the screw holes on the sides of the unit.
Fastening the unit to the factory radio mounting bracket.

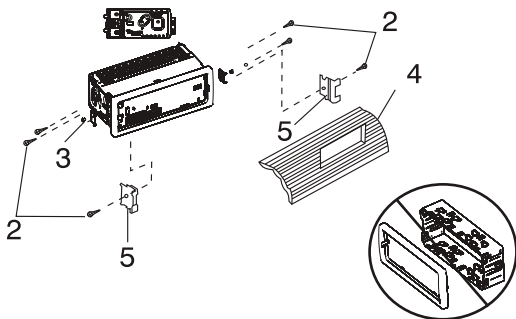

1. Select a position where the screw holes of the bracket and the screw holes of the main unit become aligned (are fitted) and tighten the screws at 2 places on each side.
2. Screw
3. Factory radio mounting bracket.
4. Dashboard or Console
5. Hook (Remove this part)

Note: the mounting box, outer trim ring, and half-sleeve are not used for method B installation.

2. DETACHABLE CONTROL PANEL (D.C.P.)

Removing The Detachable Control Panel (D.C.P.)

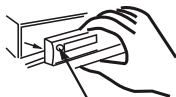

PANEL RELEASE
BUTTON

1. Turn the power off
2. Press the D.C.P. release button
3. Remove the D.C.P.

Attaching the DCP

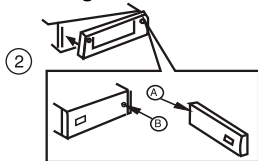

1. Attach the panel at the right side first, with point B on the main unit touching point A on the D.C.P. (As shown on the diagram).
2. Then press the left side of D.C.P. onto the main unit until a click sound is heard.

CAUTION

- DO NOT insert the D.C.P. from the left side. Doing so may damage it.
- The D.C.P. can easily be damaged by shocks. After removing it, place it in a protective case and be careful not to drop it or subject it to strong shocks.
- When the release button is pressed and the D.C.P. is unlocked, the car's vibrations may cause it to fall. To prevent damage to the D.C.P., always store it in a protective case after detaching it.
- The rear connector that connects the main unit and the D.C.P. is an extremely important part. Be careful not to damage it by pressing on it with fingernails, pens, screwdrivers, etc.

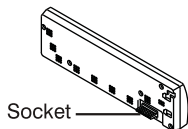

Note:

If the D.C.P. is dirty, wipe off the dirt with soft, dry cloth only. And use a cotton swab soaked in isopropyl alcohol to clean the socket on the back of the D.C.P.

DETACHABLE CONTROL PANEL (D.C.P.)

Removing The Detachable Control Panel (D.C.P.)

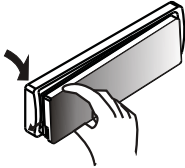
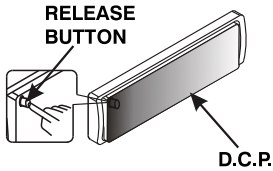

1. Turn the Power off.
2. Press the Panel Release Button.

3. Remove the D.C.P.

Attaching the Detachable Control panel (D.C.P.)

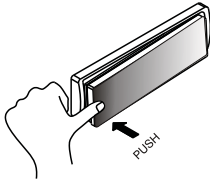
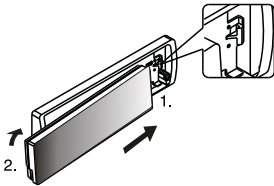

1. Insert the right side of the D.C.P. Into the main unit.
NOTE: The D.C.P. Must be attached into the T-Joint.

2. Press the D.C.P. On to the left side of middle of D.C.P. Until a click sound is heard.

CAUTION

- DO NOT insert the D.C.P. from the left side. Doing so may damage it.
- The D.C.P. can easily be damaged by shocks. After removing it, place it in a protective case and be careful not to drop it or subject it to strong shocks.
- When the release button is pressed and the D.C.P. is unlocked, the car's vibrations may cause it to fall. To prevent damage to the D.C.P. always store it in a protective case after detaching it.
- The rear connector that connects the main unit and the D.C.P. is an extremely important part. Be careful not to damage it by pressing on it with fingernails, pens, screwdrivers, etc.

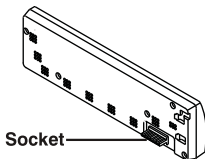

Note:

If the D.C.P. is dirty, wipe off the dirt with soft, dry cloth only. And use a cotton swab soaked in isopropyl alcohol to clean the socket on the back of the D.C.P.

ELECTRICAL CONNECTION

- Make sure your car battery is a 12 volt (6 filler caps) negative ground system (if not, a converter will be necessary).
- Before starting wiring connections, disconnect the power supply by removing the fuse from the fuse box.
- Connect the power wire to one of the extra terminals of the fuse box.
- Connect the black ground wire to a metal part of the car. It is important to make good contact.
- Make other wiring connections as shown.
- If your car does not have ISO connector, you can procure it from any car accessory shop.

Notes: INCORRECT WIRING OR OPERATION WILL AVOID THE WARRANTY OF THIS UNIT.

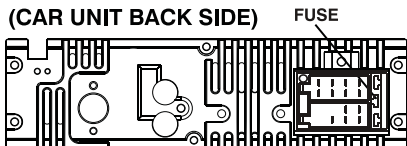

Fuse Replacement:

To replace the fuse, pull out the blown fuse from the socket. Insert a new one with same rating

GENERAL OPERATION

POWER ON/OFF BUTTON (⏻)

Press POWER button or any other button on the front of the radio to turn the unit on.
Press POWER button again to turn the unit off.

MUTE BUTTON

Press the mute button momentarily to mute the audio volume, and "Mute" will in the display. Press the mute button again to restore volume to the previous setting.

AUDIO SELECT BUTTON(ROTARY VOLUME CONTROL KNOB)

Press this button to select desired audio function.

VOLUME (VOL)->BASS (BAS)-> TREBLE (TRE)-> BALANCE (BAL)-> FADER (FAD)

Rotate Volume Control to adjust desired level within 3 seconds.

LOC/DX BUTTON

Press this button to change between Local and Distant (DX) tuning mode. Local mode improves reception in some areas where the signal is too strong.

MENU BUTTON

Press MENU button to navigate through the menu item(s). While any menu item is displayed, rotate Volume control to adjust desired setting. MENU item include:

BEEP SETTING (BEEP ON / OFF)

BEEP OFF: disable audible beep tone when any function is accessed

BEEP ON: enable audible beep tone.

EQ BUTTON (PRESET EQUALIZER)

DSP OFF->CLASSIC->POP->ROCK

At DSP off mode preset equalizer will be controlled by Bass / Treble setting.

LOUD BUTTON

Use this LOUDNESS control to increase bass output.

ROTARY ENCODER VOLUME KNOB

When the Menu function is not activated, rotate this knob to change the volume level.

When Menu function is activated, rotate this knob to navigate through different menu items.

SRC BUTTON

• Press this button to select different sources , sequence as follow:

- A) Tuner mode (Radio)
- B) USB (only if a USB drive is inserted)
- C) SD / MMC (only if a SD or MMC card is inserted))
- D) AUX IN

SOURCES PRIORITY

• Whenever a USB or SD/MMC is being inserted, unit will automatically switch to USB or SD/MMC mode, does not matter the unit is currently in what mode.

When in USB or SD / MMC mode, if the USB or SD / MMC is being removed, unit will automatically switch to radio mode.

FRONT AUX INPUT

Connect the external device to the front 3.5mm jack on front panel, then press Mode button to select Aux mode. Press Mode button again to cancel Aux Mode and return to previous mode.

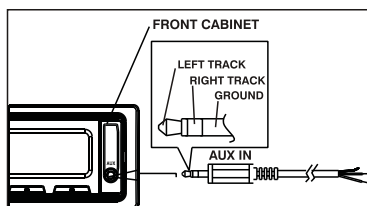

DISP BUTTON

Press DISP button once to display current playing status (e.g. Frequency of Radio/AUX/ Music information (Elapsed time and ID3) of USB /SD-MMC Play).

- During USB / SD-MMC play, Elapsed time and ID3 tag of current track will be displayed in sequence.

AUTO MEMORY STORE/PRESET SCAN BUTTON (AMS)

1.PRESET SCAN: Press AMS button briefly enter Preset Scan mode, it will scan all the preset stations in the memories, you can hear that will stay on each station for about 10 seconds.

2.AUTO MEMORY STORE: Press AMS button long to enter Auto Store mode, this feature will automatically scan the current band and enter up to 6 strongest stations into the 6 preset memories. To stop Auto Store & Scan, press the AMS button again.

TUNING UP / DOWN BUTTON (◀▶▶▶)

Press this button to search for radio stations.

BAND BUTTON

Press this button to change between bands FM1,FM2,FM3, MW1,MW2(AM).

RESET BUTTON

The RESET button is located on the front panel (as shown on the diagram). To press it vertically with a ballpoint pen or metal object will activate it. The reset button is to be activated for the following reasons:

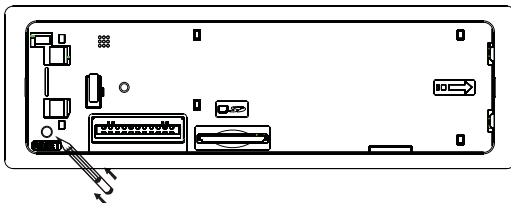

- Initial installation of the unit when all wiring is completed.
- All the function buttons do not operate.
- Error symbol on the display.

Note: If the unit cannot function normally after resetting, please use a cotton swab soaked in isopropyl alcohol to clean the socket on the back of the control panel.

LIQUID CRYSTAL DISPLAY PANEL (LCD)

The LCD panel display the frequency, time and activated functions.

NOTE:

It is a characteristic of LCD panel that if subjected to cold temperatures for an extended period of time, they will take longer time to illuminate than under normal conditions, in addition, the visibility of the numbers on the LCD may slightly decrease. The LCD read-out will return to normal when temperatures increase to a normal range.

STATION PRESET BUTTONS (M1-M6)

You can store & recall six preset radio stations by pressing M1-M6 buttons

TO STORE A STATION: 1) select a band (if needed)

2) select a station by tuning up / down button

3) hold a preset button which you want store the station for at least 2 seconds. The preset number will appear on the display accompanied by a beeps sound.

TO RECALL A STATION: 1) select a band (if needed)

2) press a preset button briefly to recall the stored station.

MP3/SD/USB OPERATIONS

M1)PLAY/PAUSE AND FIRST TRACK BUTTON

Press this button briefly to pause MP3 play, press again to release pause.

M2)INTRO SCAN BUTTON

Press this button to select Intro Scan function, the first 10 seconds of each track will be played sequentially until this button is pressed again, then normal play will resume at the current track.

M3)REPEAT BUTTON

Pressing this button will activate Repeat Function in the following order :

Repeat On → Repeat Off

M4)RANDOM PLAY BUTTON

When random play mode is selected, the tracks will be played in random order, press this key one more time to cancel random play mode.

TRACK UP AND TRACK DOWN BUTTON (◀◀▶▶)

Under normal play mode, press the Track Up Button for less than 1 second to skip the playback to the next track, or press the Track Down Button for less than 1 seconds to return to the beginning of the current track, press this button one more time to skip to the previous track.

When any of these buttons is pressed for more than 1 second, the Mp3 player will enter Cue/Review mode, this is indicated by the flashing track number on the LCD. When the key is released, normal play will resume.

MMC/SD CARD & USB DEVICE OPERATIONS

START THE USB DEVICE MODE

1.The USB socket is accessible as indicated in picture 1.(P.1)

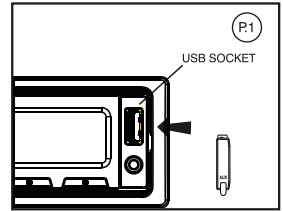

2.Plug in the USB drive / device completely as indicated in picture 2(P.2) and display will show USB-LOAD to indicate that the USB drive / device is being plugged in correctly & the download has begun.

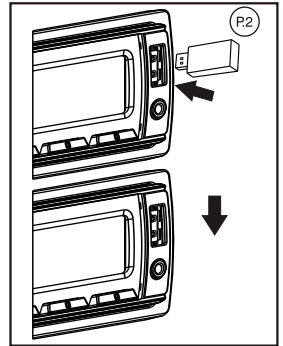

3.Does not matter which source the unit is in (TUNER,SD/MMC,AUX,etc), once a USB drive / device is being plugged into the unit, unit will automatically switch to USB mode.

4.All the USB files playback function is same as normal MP3 files playback.

Warning: Excessive weight or size USB drive/device may cause permanent & serious damage to the unit and may cause access to the buttons on the front panel impossible. User must use an extension cable (provide by USB device manufacturer) to connect with USB socket to prevent any damage cause.

TO STOP USB PLAYBACK

1.If the USB drive / device is unplugged, the unit will automatically switch to radio mode. Or user can use SRC button to switch to other mode.

2.User can use the SRC button to choose USB mode (only if USB drive / device is inserted in the unit) or any other modes, when they are in any mode.

USB SPECIFICATION

- * SUPPORT MAX 32G USB FLASH MEMORY
- * SUPPORT MAX 9999 SONGS
- * USB 1.1 DEVICE SUPPORT
- * USB 2.0 DEVICE SUPPORT
(TRANSFER SPEED SAME AS VER 1.1)
- * FILE MANAGER: FAT12/FAT16/FAT32
- * CURRENT SUPPLY: MAX 500mA

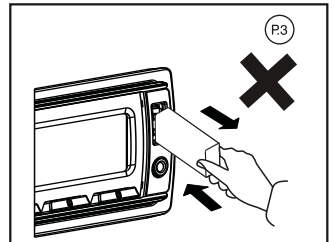

CAUTION

1.Always unplugged the USB gently from the unit, excessive force used will cause permanent & serious damage to the unit & the USB drive / device.

COMPATIBILITY

Due to the fast changing technology world, this unit may or may not be compatible to all the USB drive / device available with all the future technology, especially those USB drive / device which require to install a driver. Always choose a compatible USB drive / device which is compatible with this unit.

NOTE:

This unit is not compatible with portable Hard-Disc.

START THE SD/MMC MODE

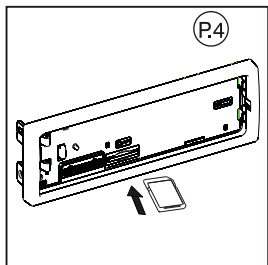

- 1.The SD/MMC card slot is located on top of the front panel as indicated in (P.4).
2. Insert the SD/MMC card into the card slot in the correct direction until a CLICK sound is heard.
3. The display will show SD-MMC to indicate that the SD or MMC card is correctly inserted. Once the SD or MMC card is inserted, the MP3 file will automatically loaded & playback will also start.
4. Does not matter the unit is in what sources (Tuner,USB,AUX, etc),once a SD or MMC card is being inserted in the unit, unit will automatically switch to SD / MMC mode.
5. All the SD / MMC files playback function is same as normal MP3 files playback.

TO STOP SD/MMC CARD PLAYBACK

- 1.Push on the end of the SD or MMC card to eject the sd or MMC card. Once the SD or MMC card is taken out, the unit will automatically switch to previous mode.
- 2.User can use the SRC button to choose SD / MMC mode (only if SD or MMC is inserted in the unit) or any other modes, when they are in any mode.

SD/MMC SPECIFICATION

- * SUPPORT MAX 32G SD/MMC CARD
- * SUPPORT MAX 9999 SONGS
- * FILE MANAGER FAT12, FAT16, FAT32 SUPPORTED

CAUTION

- 2.Please make sure to insert the SD or MMC card in the correct direction / orientation as indicated in picture 6(P.5). Wrong insert will cause permanent & serious damage to the unit & the SD or MMC card.

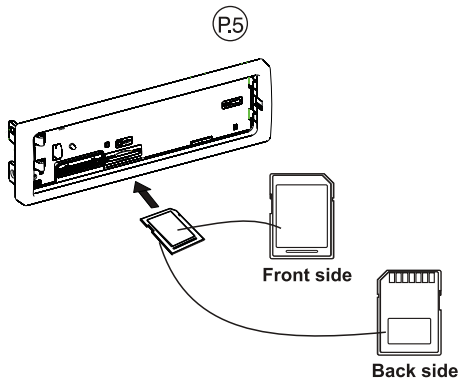

MP3 OPERATIONS(MP3/SD/MMC/USB FILES)

Loading MP3 File (MMC/SD/USB Drive)

During MP3 play, Current Track Number & Time Elapse of current track will be shown on the LCD.

If the disc is ID3 compatible, press DISP button to display elapsed time and ID3 tag of current track, The following categories of ID3 tag will be shown:

1. Track name SONG
2. Title name TITLE
3. Artist name ARTIST
4. Album name ALBUM
5. Folder name DIR

Navigating Through Folders and Tracks

There are Four ways to select your favourite folder/tracks.

1.By Track Up/Down Button (◀◀ ▶▶)

Press track up/down button to skip the current tracks.

2.10-Track Up/Down Button

Press Folder up (M6)/F+ or Folder down Button (M5)/F- for more than 1seconds skip10 tracks.

3.Folder UP/Down

Press Folder up (M6)/F+ or Folder down Button (M5)/F- briefly to skip Folder.

4.NAVIGATING THROUGH DIRECTORIES AND TRACKS

Under MP3 play modes, press AMS Menu button once, the display shows TRK-SCH, then turn the Encoder Volume knob to select desired track number directly, Then press Volume knob to confirm.

SPECIFICATIONS

RADIO SECTION

FM

Frequency Range	87.5 - 107.9 MHz
Usable Sensitivity	Better than 15dB at S/N 30 dB
Stereo Separation	25 dB at 1KHz
S/N Ratio	50 dB

AM (MW)

Frequency Range	530 - 1710 KHz
Usable Sensitivity	Better than 45dB
S/N Ratio	40 dB

GENERAL

Power Supply	DC 11 -14V
Polarity	Negative Ground
Speaker impedance	4 ohms
Power Output	50W x 4

REMARK :

Specifications subject to change without notice.