

JAN-7201S/9201S ECDIS

JRC

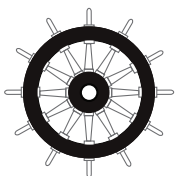

* The photograph includes options.

- Provide a smooth operating environment ensured by high-speed chart drawing.

- **Conforming to the latest IMO performance standards with Marine Equipment Directive (MED) certification.**
- **Ensuring intuitive and easy-to-use display and operation performance reflecting professional user's voices.**
- **Integrating route editing and route safety checking to support safer route plans.**
- **ECDIS type-specific training (TST) is provided by a variety of organizations around the world on behalf of JRC.**
- **Selectable screen size, 19-inch (SXGA) or 26-inch (WUXGA) as customer's choice.**

JAN-7201S/9201S

Mandatory installation and standards

ECDIS

The Electronic Chart Display and Information System (ECDIS) is a geographic information system for voyage planning and route monitoring to support the safety navigation of ships at sea. And in response to the latest revision of the International Convention for the Safety of Life at Sea (SOLAS), the International Maritime Organization (IMO) enforced the mandatory installation of the ECDIS by July 2018 according to vessel's category. (Requirements for the equipment and operation qualification are subject to approval from the country with which the ship is registered and recommendations from the classification society of the ship.)

The ECDIS onboard a ship uses information from the automatic identification system (AIS) and superposes the images with navigational chart information, thus accurately displaying dynamic information on other ships around. Also the ECDIS plays central roles in the safe navigation of the ship and provides safety functions, including the generation of warnings when the ship approaches dangerous areas. The ECDIS is useful for marine accident avoidance and serves as equipment indispensable to the safe navigation of ships.

Regulations and major specifications

This equipment conforms to the requirements set out in the IMO's resolution MSC.191 (79) for display-related voyage information adopted in December 2004 and the IMO Resolution MSC.232 (82) for ECDIS performance standards adopted in December 2006.

Other specifications of the ECDIS are shown below.

- Electronic chart display function : IEC 61174
- Display-related voyage information : IEC 62288

Route editing and safety checking

JRC's new ECDIS model JAN-7201S/9201S has integrated route editing, which was conventionally divided into two segments, i.e., graphics input and numeric table input areas, into one. Waypoints, if specified, on a navigational chart are immediately quantified and added to the numeric editing table, and the numeric data on the waypoints that is input into the editing table is immediately reflected on the navigational chart. Up to four routes can be edited at the same time, and a portion cut out of any route can be combined and the routes can be all or partly replaced or edited.

Furthermore, a safety check on edited route data is possible with a click of a button.

Detected error information items, if any, are listed and displayed, and the corresponding route portions are highlighted in the chart and table, which can be confirmed at a glance to take remedial measures.



Route editing screen example

JAN-7201S/9201S

Features



Sophisticated user interface

The JAN-7201S/9201S incorporates a new user interface (named jGUI) for an intuitive, easy-to-use, simple menu system based on the display of icons. This interface always displays critical data in fixed positions on the screen while icon-based menu display informs users of corresponding functions straightaway. Furthermore, target tracking (TT) and AIS symbols feature pop-up displays while mouseover on the target showing their main data at a glance.

Easy-to-use operating unit

The newly designed trackball supports all the operation of the equipment. Users will be alerted with alarms from the operating unit and color changes under situations that require attention.



Optional keyboard

The ECDIS will be operable like conventional models by connecting an optional operating unit that incorporates dedicated function buttons, control knobs and a full keyboard adopting the QWERTY layout.



Operation unit with optional keyboard

Selectable screen sizes

A newly designed narrow-frame 19 inch (SXGA) and 26 inch (WUXGA) LCD monitors are prepared for the JAN-7201S/9201S. Each monitor adopts an LED backlight, thus providing high-quality images that are highly visible both during the day and at night.



JAN-7201S



JAN-9201S

JAN-7201S/9201S

Technical training

Type-specific training (TST)

Unlike JRC's conventional ECDIS models, this ECDIS has adopted a new operation system and a TST program supporting the new operation system is required. The TST for the new ECDIS is given at JRC's major branches, agents, and training institutions around the world. The training will be given onboard or offices by instructors dispatched at the request of customers. Furthermore, PC software is available for users' self-learning at home or onboard. For more information about TST, contact your JRC representative.

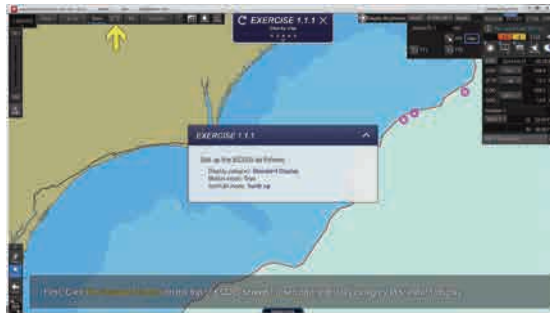

Correspond to the major chart

The JAN-7201S/9201S supports the display of major electronic navigational charts (ENCs), including those provided by ADMIRALTY Vector Chart Service (AVCS) (S-57 Ed 3.0/3.1 and S-63), NAVTOR ENC Service, and Jeppesen ENC Service as well as ADMIRALTY Raster Chart Service (ARCS). Also, it supports advanced features provided with ENCs, such as the Admiralty Information Overlay (AIO) of AVCS by the United Kingdom Hydrographic Office (UKHO) and Dynamic Licensing of Jeppesen ENC service.

ENC (S-57 and S-63 vector charts)

- AVCS (AIO supported)
- NAVTOR ENC Service (PAYS supported)
- Jeppesen ENC Service (Dynamic Licensing supported)

Raster charts

- ARCS
- Others (private charts)
- Jeppesen Ed.3 Professional
- Jeppesen Ed.3 Professional+

Block diagram

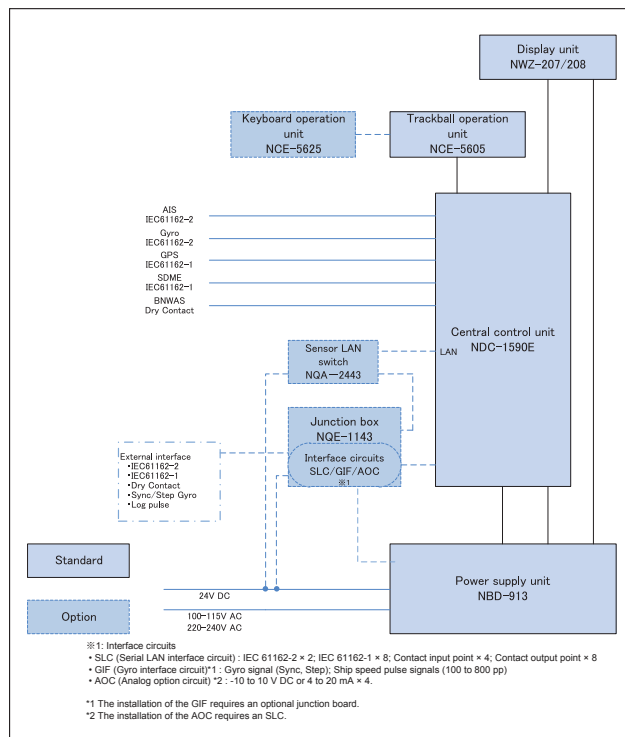

In the box

- Central control unit
- Power supply unit
- Display unit
- Trackball operation unit

Options

- Keyboard operation unit
- Sensor LAN switch
- Junction box
- Serial LAN interface circuit (SLC)
- Gyro interface circuit (GIF)*1
- Analog option circuit (AOC)*2

*1 The installation of the GIF requires an optional junction board.

*2 The installation of the AOC requires an SLC.

JAN-7201S/9201S

Dimensions and weight

19-inch monitor and desktop frame*

NWZ-207 Weight: 6 kg

CWB-1594 Weight: 3.6 kg

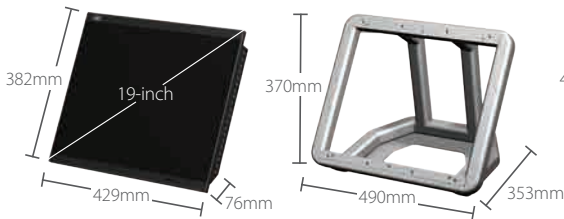

26-inch monitor and desktop frame*

NWZ-208 Weight: 16 kg

CWB-1595 Weight: 5.5 kg

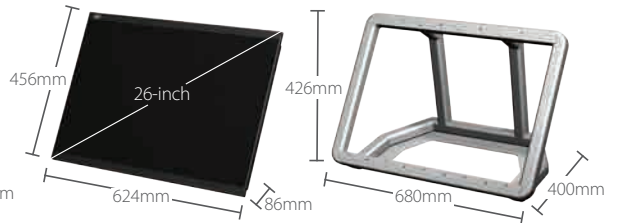

* Desktop frame is option.

Central control unit

NDC-1590E Weight: 5.6 kg



Power supply unit

NBD-913 Weight: 4.2 kg



Trackball operation unit

NBD-5605 Weight: 1.3 kg



Keyboard operation unit (option)

NBD-5625 Weight: 0.8 kg



Junction box (option)

NQE-1143 Weight: 3.8 kg

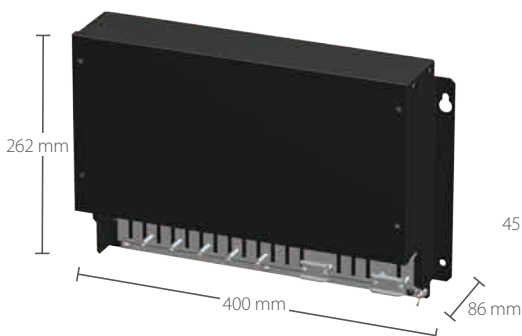

Operation unit desktop frame and large tray*

CWB-1596 Weight: 1 kg

CWB-1593 Weight: 0.3 kg

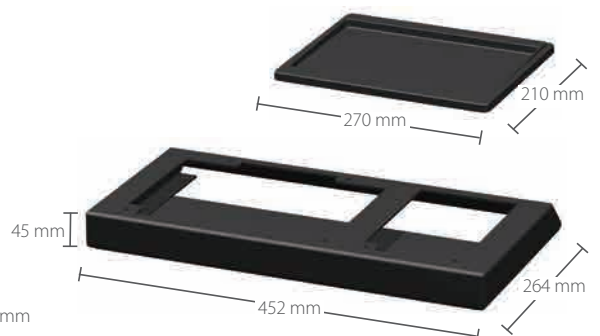

* Operation unit desktop frame and large tray are option.

JAN-7201S/9201S

Specifications

Model	19-inch model	JAN-7201S
	26-inch model	JAN-9201S
Conforming to IMO standards		✓
Hardware function		
Display unit		JAN-7201S: 19-inch SXGA color LCD, 1280 × 1024 pixels JAN-9201S: 26-inch WUXGA color LCD, 1920 × 1200 pixels
Central control block		Intel Core i5 2515E 2.5GHz 2GB main memory SSD × 2 DVD drive × 1
Power supply		24V DC and single-phase 100 to 115V AC or 220 to 240 V AC at 50/60 Hz
Power consumption		Rating JAN-7201S: 200 VA approx., JAN-9201S: 240 VA approx.
Chart display function		
Chart database		ENC: S-57 Ed3.0/3.1 and S-63 AVCS (AIO supported), NAVTOR ENC Service, Jeppesen ENC Service Raster charts: ARCS Personal chart: Jeppesen Ed.3 Professional / Professional+
Operation mode		TM (true motion)/RM (relative motion) display
Azimuth display mode		True motion mode: North UP/Course UP/Head UP/Waypoint UP Relative motion mode: North UP/Course UP/Head UP/Waypoint UP
Scale		1:1,000 to 1:40,000,000 (SXGA) / 1:20,000,000 (WUXGA)
Range		0.125, 0.25, 0.5, 0.75, 1.5, 3, 6, 12, 24, 48, 96NM
Multi-window display		Upper-lower split / Left-right split / Picture-in-picture
Route planning function		
Route creation		Table/Graphic editing
Route editing		Waypoint addition / deletion / edition Alternative route creation Route copy Connection between routes Import / export (in CSV)
Safety check		Yes
Number of routes displayed		Four types max.
Navigation-monitoring function		
Own ship		Monitoring for position, wake, and dragging anchor
Route monitoring		Water depths, obstacles, approaching prohibited areas, course deviation, waypoints, and arrival time
Other ship monitoring		AIS display: 500 targets max.
User map		
Number of display points		100,000 points (marks and lines)
Import/Export		Possible with USB memory
Other functions		
Data display function		Conning data block display
Self-diagnostic function		Standard
Remote maintenance function		Standard
Playback		Navigation data (3 months max.) Logbook (3 months max.)

- Specifications may be subject to change without notice.